

Model 3051S Series Pressure Transmitter Family

with FOUNDATION™ Fieldbus protocol



ROSEMOUNT®

www.rosemount.com



EMERSON™
Process Management

Model 3051S Series Pressure Transmitter with FOUNDATION Fieldbus Protocol

NOTICE

Read this manual before working with the product. For personal and system safety, and for optimum product performance, make sure you thoroughly understand the contents before installing, using, or maintaining this product.

Within the United States, Rosemount Inc. has two toll-free assistance numbers:

Customer Central

Technical support, quoting, and order-related questions.

1-800-999-9307 (7:00 am to 7:00 pm CST)

North American Response Center

Equipment service needs.

1-800-654-7768 (24 hours—includes Canada)

Outside of the United States, contact your local Rosemount® representative.

⚠ CAUTION

The products described in this document are NOT designed for nuclear-qualified applications. Using non-nuclear qualified products in applications that require nuclear-qualified hardware or products may cause inaccurate readings.

For information on Rosemount nuclear-qualified products, contact your local Rosemount Sales Representative.

Table of Contents

SECTION 1	
Introduction	
	Overview 1-1
	Using This Manual 1-1
	Service Support 1-2
	Device Description 1-2
	Node Address 1-2
	Foundation fieldbus function blocks 1-2
SECTION 2	
Configuration	
	Overview 2-1
	Safety Messages 2-1
	Warnings 2-1
	General Block Information 2-2
	Modes 2-2
	Link Active Scheduler 2-3
	Block Instantiation 2-3
	Capabilities 2-4
	Resource Block 2-4
	FEATURES and FEATURES_SEL 2-4
	MAX_NOTIFY 2-5
	PlantWeb™ Alarms 2-6
	Sensor Transducer Block 2-9
	Zero Trim 2-9
	Damping 2-9
	Analog Input (AI) Function Block 2-9
	Configure the AI block 2-9
	Configuration Examples 2-11
	Pressure transmitter 2-11
	Pressure transmitter used to measure level in an open tank 2-11
	Differential pressure transmitter to measure flow 2-13
	Filtering 2-14
	Low Cut 2-14
	Process Alarms 2-15
	Alarm Priority 2-15
	Status Options 2-15
	Advanced Features 2-15
	LCD Transducer Block 2-16
	Custom Meter Configuration 2-16
	Display bar graph 2-18

Model 3051S Series

	Advanced Diagnostics Transducer Block (ADB)	2-18
	ADB Parameters	2-18
	Plugged Impulse Line Detection (PIL)	2-18
	Configuration of the Plugged Impulse Line Detection	2-19
	Plugged Impulse Line Advanced Settings	2-20
	Statistical Process Monitoring (SPM)	2-22
	SPM Configuration	2-23
SECTION 3		
Operation and	Overview	3-1
Maintenance	Safety Messages	3-1
	Warnings	3-1
	Resource Block	3-2
	Advanced Diagnostics Block Licensing	3-2
	Master Reset Method	3-3
	Sensor Transducer Block	3-3
	Sensor Calibration, Upper and Lower Trim Methods	3-3
	Sensor Calibration, Zero Trim Method	3-4
	Factory Trim Recall Method	3-4
	Analog Input (AI) Function Block	3-4
	Status	3-4
	Simulation	3-5
	Advanced Diagnostics Transducer Block (ADB)	3-6
	Status of the Plugged Impulse Line	3-6
	Monitoring and Status of the SPM	3-6
SECTION 4		
Troubleshooting	Overview	4-1
	Safety Messages	4-1
	Warnings	4-1
	Troubleshooting Guides	4-2
	Resource Block	4-5
	Sensor Transducer Block	4-6
	Analog Input (AI) Function Block	4-7
	LCD Transducer block	4-7
	Advanced Diagnostics Transducer Block (ADB)	4-8
APPENDIX A		
Block Information	Overview	A-1
	Resource Block	A-1
	Parameters and Descriptions	A-2
	Sensor Transducer Block	A-5
	Parameters and Descriptions	A-5
	Analog Input (AI) Function Block	A-8
	AI Parameter Table	A-9
	LCD Transducer Block	A-12
	Advanced Diagnostics Transducer Block (ADB)	A-13

Section 1 Introduction

OVERVIEW

This manual was developed with the assumption that the user will have a basic understanding of FOUNDATION Fieldbus concepts and wiring practices.

Information is available at www.plantweb.emersonprocess.com/university or check with your system integrator about resources for your specific host system.

USING THIS MANUAL

The sections in this manual provide information on configuring, troubleshooting, operating and maintaining Rosemount Model 3051S Series Pressure Transmitters specifically for FOUNDATION fieldbus protocol.

NOTE

For installation, specifications, dimensional drawings, ordering tables, spare part tables, and approval information refer to the Model 3051S Series Pressure Transmitter manual 00809-0100-4801.

Table 1-1. Location of fieldbus information

Section	Fieldbus
Installation	Refer to the Model 3051S manual 00809-0100-4801
Configuration	Included in this fieldbus supplement
Operation and Maintenance	Included in this fieldbus supplement
Troubleshooting	Included in this fieldbus supplement
Reference data	Refer to the Model 3051S manual 00809-0100-4801
Approvals	Refer to the Model 3051S manual 00809-0100-4801
Block Information	Parameters are included in this fieldbus supplement, other block information can be found in 00809-0100-4783.

The sections in this manual are organized as follows:

- **Section 2: Configuration** provides instruction on configuration of the Model 3051S Series transmitters with fieldbus protocol. Information on software functions, configuration parameters, and other variables are also included.
- **Section 3: Operation and Maintenance** contains operation and maintenance techniques.
- **Section 4: Troubleshooting** provides troubleshooting techniques for the most common operating problems.
- **Appendix A: Block Information** supplies reference block information such as parameter tables.

Model 3051S Series

Service Support

To expedite the return process outside of the United States, contact the nearest Rosemount representative.

Within the United States, call the Rosemount National Response Center using the 1-800-654-RSMT (7768) toll-free number. This center, available 24 hours a day, will assist you with any needed information or materials.

The center will ask for product model and serial numbers, and will provide a Return Material Authorization (RMA) number. The center will also ask for the process material to which the product was last exposed.

⚠ CAUTION

Individuals who handle products exposed to a hazardous substance can avoid injury if they are informed of and understand the hazard. If the product being returned was exposed to a hazardous substance as defined by OSHA, a copy of the required Material Safety Data Sheet (MSDS) for each hazardous substance identified must be included with the returned goods.

Rosemount National Response Center representatives will explain the additional information and procedures necessary to return goods exposed to hazardous substances.

DEVICE DESCRIPTION

Before configuring the device, ensure the host has the appropriate Device Description file revision for this device. The device descriptor can be found on www.rosemount.com. The initial release of the Model 3051S with FOUNDATION fieldbus protocol is device revision 20.

NODE ADDRESS

The transmitter is shipped at a temporary (248) address. This will enable FOUNDATION fieldbus host systems to automatically recognize the device and move it to a permanent address.

FOUNDATION FIELDBUS FUNCTION BLOCKS

For reference information on the Resource, Sensor Transducer, AI, LCD Transducer, Advanced Diagnostics Transducer blocks refer to "Block Information" on page A-1. Reference information on the ISEL, INT, ARTH, SGCR and PID blocks can be found in the Function Block manual document number 00809-0100-4783.

Resource Block (1000)

The Resource block contains diagnostic, hardware and electronics information. There are no linkable inputs or outputs to the Resource Block.

Sensor Transducer Block (1100)

The Sensor Transducer Block contains sensor information including the sensor diagnostics and the ability to trim the pressure sensor or recall factory calibration.

LCD Transducer Block (1200)

The LCD Transducer Block is used to configure the LCD meter.

Advanced Diagnostics Transducer Block (1300)

The Advanced Diagnostics Transducer Block allows a user to view, configure and monitor the plugged impulse line detection and statistical process monitoring diagnostics.

Model 3051S Series

Analog Input Block (1400)

The Analog Input (AI) Function Block processes the measurements from the sensor and makes them available to other function blocks. The output value from the AI block is in engineering units and contains a status indicating the quality of the measurement. The AI block is widely used for scaling functionality.

Input Selector Block (1500)

The Input Selector (ISEL) Function Block can be used to select the first good, Hot Backup, maximum, minimum, or average of as many as eight input values and place it at the output. The block supports signal status propagation.

Integrator Block (1600)

The Integrator (INT) Function Block integrates one or two variables over time. The block compares the integrated or accumulated value to pre-trip and trip limits and generates discrete output signals when the limits are reached.

Arithmetic Block (1700)

The Arithmetic (ARTH) Function Block provides the ability to configure a range extension function for a primary input. It can also be used to compute nine different arithmetic functions.

Signal Characterizer Block (1800)

The Signal Characterizer (SGCR) Function Block characterizes or approximates any function that defines an input/output relationship. The function is defined by configuring as many as twenty X,Y coordinates. The block interpolates an output value for a given input value using the curve defined by the configured coordinates. Two separate analog input signals can be processed simultaneously to give two corresponding separate output values using the same defined curve.

PID Block (1900)

The PID Function Block combines all of the necessary logic to perform proportional/integral/derivative (PID) control. The block supports mode control, signal scaling and limiting, feed forward control, override tracking, alarm limit detection, and signal status propagation.

The block supports two forms of the PID equation: Standard and Series. You can choose the appropriate equation using the MATHFORM parameter. The Standard ISA PID equation is the default selection.

Model 3051S Series

Section 2 Configuration

General Block Information	page 2-2
Resource Block	page 2-4
Sensor Transducer Block	page 2-9
Analog Input (AI) Function Block	page 2-9
LCD Transducer Block	page 2-16
Advanced Diagnostics Transducer Block (ADB)	page 2-18

OVERVIEW

This section covers basic operation, software functionality, and basic configuration procedures for the Model 3051S pressure transmitter with FOUNDATION fieldbus. This section is organized by block information. For detailed information about the function blocks used in the Model 3051S pressure transmitter, refer to “Block Information” on page A-1 and the Foundation fieldbus Block manual (00809-0100-4783).

SAFETY MESSAGES

Procedures and instructions in this section may require special precautions to ensure the safety of the personnel performing the operations. Information that raises potential safety issues is indicated by a warning symbol (⚠). Refer to the following safety messages before performing an operation preceded by this symbol.

Warnings

⚠ WARNING

Explosions can result in death or serious injury.

- Do not remove the transmitter covers in explosive environments when the circuit is live.
- Transmitter covers must be fully engaged to meet explosion proof requirements.
- Before connecting a configuration tool in an explosive atmosphere, make sure the instruments in the loop are installed in accordance with intrinsically safe or nonincendive field wiring practices.

⚠ WARNING

Electrical shock can result in death or serious injury.

- Avoid contact with the leads and terminals. High voltage that may be present on leads can cause electrical shock.

Model 3051S Series

GENERAL BLOCK INFORMATION

Modes

The Resource, Transducer, and all function blocks in the device have modes of operation. These modes govern the operation of the block. Every block supports both automatic (AUTO) and out of service (OOS) modes. Other modes may also be supported.

Changing Modes

To change the operating mode, set the MODE_BLK.TARGET to the desired mode. After a short delay, the parameter MODE_BLOCK.ACTUAL should reflect the mode change if the block is operating properly.

Permitted Modes

It is possible to prevent unauthorized changes to the operating mode of a block. To do this, configure MODE_BLOCK.PERMITTED to allow only the desired operating modes. It is recommended to always select OOS as one of the permitted modes.

Types of Modes

For the procedures described in this manual, it will be helpful to understand the following modes:

AUTO

The functions performed by the block will execute. If the block has any outputs, these will continue to update. This is typically the normal operating mode.

Out of Service (OOS)

The functions performed by the block will not execute. If the block has any outputs, these will typically not update and the status of any values passed to downstream blocks will be "BAD". To make some changes to the configuration of the block, change the mode of the block to OOS. When the changes are complete, change the mode back to AUTO.

MAN

In this mode, variables that are passed out of the block can be manually set for testing or override purposes.

Other Types of Modes

Other types of modes are Cas, RCas, ROut, IMan and LO. Some of these may be supported by different function blocks in the Model 3051S. For more information, see the Function Block manual, document 00809-0100-4783.

NOTE

When an upstream block is set to OOS, this will impact the output status of all downstream blocks. The figure below depicts the hierarchy of blocks:

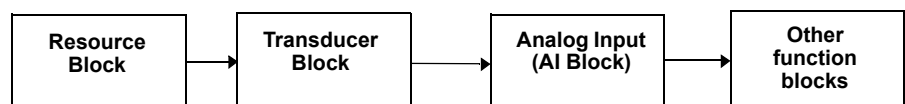

Link Active Scheduler

The Model 3051S can be designated to act as the backup Link Active Scheduler (LAS) in the event that the LAS is disconnected from the segment. As the backup LAS, the Model 3051S will take over the management of communications until the host is restored.

The host system may provide a configuration tool specifically designed to designate a particular device as a backup LAS. Otherwise, this can be configured manually as follows:

- ⚠ 1. Access the Management Information Base (MIB) for the Model 3051S.
2. To activate the LAS capability, write 0x02 to the BOOT_OPERAT_FUNCTIONAL_CLASS object (Index 605). To deactivate, write 0x01.
3. Restart the processor.

Block Instantiation

Rosemount devices are pre-configured with function blocks at the factory, the default permanent configuration for the Model 3051S is listed below. The Model 3051S can have up to five additional instantiated function blocks.

- 2 Analog Input Blocks (tag names AI 1400, AI 1500)
- 1 Proportional/Integral/Derivative Block (tag name PID 1600)
- 1 Input Selector Block (tag name ISEL 1700)
- 1 Signal Characterizer Block (tag name CHAR 1800)
- 1 Arithmetic Block (tag name ARITH 1900)
- 1 Integrator Block (tag name INTEG 2000)

The Model 3051S supports the use of Function Block Instantiation. When a device supports block instantiation, the number of blocks and block types can be defined to match specific application needs. The number of blocks that can be instantiated is only limited by the amount of memory within the device and the block types that are supported by the device. Instantiation does not apply to standard device blocks like the Resource, Sensor Transducer, LCD Transducer, and Advanced Diagnostics Blocks.

By reading the parameter "FREE_SPACE" in the Resource block you can determine how many blocks you can instantiate. Each block that you instantiate takes up 4.5573% of the "FREE_SPACE".

Block instantiation is done by the host control system or configuration tool, but not all hosts are required to implement this functionality. Please refer to your specific host or configuration tool manual for more information.

Model 3051S Series

Capabilities

Virtual Communication Relationship (VCRs)

There are a total of 20 VCRs. Two are permanent and 18 are fully configurable by the host system. Thirty link objects are available.

Network Parameter	Value
Slot Time	6
Maximum Response Delay	4
Maximum Inactivity to Claim LAS Delay	60
Minimum Inter DLPDU Delay	7
Time Sync class	4 (1ms)
Maximum Scheduling Overhead	21
Per CLPDU PhL Overhead	4
Maximum Inter-channel Signal Skew	0
Required Number of Post-transmission-gab-ext Units	0
Required Number of Preamble-extension Units	1

Host timer recommendations

T1 = 96000
 T2 = 1920000
 T3 = 480000

Block Execution times

Analog Input = 20 ms
 PID = 25 ms
 Arithmetic = 20 ms
 Input Selection = 20 ms
 Signal Characterizer = 20 ms
 Integrator = 20 ms

RESOURCE BLOCK

FEATURES and FEATURES_SEL

The parameters FEATURES and FEATURE_SEL determine optional behavior of the Model 3051S.

FEATURES

The FEATURES parameter is read only and defines which features are supported by the Model 3051S. Below is a list of the FEATURES the Model 3051S supports.

UNICODE

All configurable string variables in the Model 3051S, except tag names, are octet strings. Either ASCII or Unicode may be used. If the configuration device is generating Unicode octet strings, you must set the Unicode option bit.

REPORTS

The Model 3051S supports alert reports. The Reports option bit must be set in the features bit string to use this feature. If it is not set, the host must poll for alerts.

SOFT W LOCK and HARD W LOCK

Inputs to the security and write lock functions include the hardware security switch, the hardware and software write lock bits of the FEATURE_SEL parameter, the WRITE_LOCK parameter, and the DEFINE_WRITE_LOCK parameter.

The WRITE_LOCK parameter prevents modification of parameters within the device except to clear the WRITE_LOCK parameter. During this time, the block will function normally updating inputs and outputs and executing algorithms. When the WRITE_LOCK condition is cleared, a WRITE_ALM alert is generated with a priority that corresponds to the WRITE_PRI parameter.

The FEATURE_SEL parameter enables the user to select a hardware or software write lock or no write lock capability. To enable the hardware security function, enable the HW_SEL bit in the FEATURE_SEL parameter. When this bit has been enabled the WRITE_LOCK parameter becomes read only and will reflect the state of the hardware switch. In order to enable the software write lock, the SW_SEL bit must be set in the FEATURE_SEL parameter. Once this bit is set, the WRITE_LOCK parameter may be set to “Locked” or “Not Locked.” Once the WRITE_LOCK parameter is set to “Locked” by either the software or the hardware lock, all user requested writes as determined by the DEFINE_WRITE_LOCK parameter shall be rejected.

The DEFINE_WRITE_LOCK parameter allows the user to configure whether the write lock functions (both software and hardware) will control writing to all blocks, or only to the resource and transducer blocks. Internally updated data such as process variables and diagnostics will not be restricted by the security switch.

The following table displays all possible configurations of the WRITE_LOCK parameter.

FEATURE_SEL HW_SEL bit	FEATURE_SEL SW_SEL bit	SECURITY SWITCH	WRITE_LOCK	WRITE_LOCK Read/Write	DEFINE_WRITE_LOCK	Write access to blocks
0 (off)	0 (off)	NA	1 (unlocked)	Read only	NA	All
0 (off)	1 (on)	NA	1 (unlocked)	Read/Write	NA	All
0 (off)	1 (on)	NA	2 (locked)	Read/Write	Physical	Function Blocks only
0 (off)	1 (on)	NA	2 (locked)	Read/Write	Everything	None
1 (on)	0 (off) ⁽¹⁾	0 (unlocked)	1 (unlocked)	Read only	NA	All
1 (on)	0 (off)	1 (locked)	2 (locked)	Read only	Physical	Function Blocks only
1 (on)	0 (off)	1 (locked)	2 (locked)	Read only	Everything	None

(1) The hardware and software write lock select bits are mutually exclusive and the hardware select has the highest priority. When the HW_SEL bit is set to 1 (on), the SW_SEL bit is automatically set to 0 (off) and is read only.

FEATURES_SEL

FEATURES_SEL is used to turn on any of the supported features. The default setting of the Model 3051S does not select any of these features. Choose one of the supported features if any.

MAX_NOTIFY

The MAX_NOTIFY parameter value is the maximum number of alert reports that the resource can have sent without getting a confirmation, corresponding to the amount of buffer space available for alert messages. The number can be set lower, to control alert flooding, by adjusting the LIM_NOTIFY parameter value. If LIM_NOTIFY is set to zero, then no alerts are reported.

Model 3051S Series

PlantWeb™ Alarms

The alarms and recommended actions should be used in conjunction with Section 4: Troubleshooting.

The Resource Block will act as a coordinator for PlantWeb alarms. There will be three alarm parameters (FAILED_ALARM, MAINT_ALARM, and ADVISE_ALARM) which will contain information regarding some of the device errors which are detected by the transmitter software. There will be a RECOMMENDED_ACTION parameter which will be used to display the recommended action text for the highest priority alarm. FAILED_ALARM will have the highest priority followed by MAINT_ALARM and ADVISE_ALARM will be the lowest priority.

FAILED_ALARMS

A failure alarm indicates a failure within a device that will make the device or some part of the device non-operational. This implies that the device is in need of repair and must be fixed immediately. There are five parameters associated with FAILED_ALARMS specifically, they are described below.

FAILED_ENABLED

This parameter contains a list of failures in the device which makes the device non-operational that will cause an alarm to be sent. Below is a list of the failures with the highest priority first.

1. Memory Failure
2. NV Memory Failure
3. Primary Value Failure
4. Secondary Value Failure
5. Sensor Module Memory Failure

FAILED_MASK

This parameter will mask any of the failed conditions listed in FAILED_ENABLED. A bit on means that the condition is masked out from alarming and will not be reported.

FAILED_PRI

Designates the alarming priority of the FAILED_ALM, see "Alarm Priority" on page 2-15. The default is 0 and the recommended value are between 8 and 15.

FAILED_ACTIVE

This parameter displays which of the alarms is active. Only the alarm with the highest priority will be displayed. This priority is not the same as the FAILED_PRI parameter described above. This priority is hard coded within the device and is not user configurable.

FAILED_ALM

Alarm indicating a failure within a device which makes the device non-operational.

MAINT_ALARMS

A maintenance alarm indicates the device or some part of the device needs maintenance soon. If the condition is ignored, the device will eventually fail. There are five parameters associated with MAINT_ALARMS, they are described below.

MAINT_ENABLED

The MAINT_ENABLED parameter contains a list of conditions indicating the device or some part of the device needs maintenance soon. If the condition is ignored, the device will eventually fail.

Below is a list of the conditions with the highest priority first.

1. Sensor Module Memory Warning
2. Primary Value Degraded
3. Secondary Value Degraded
4. Plugged Impulse Line Detected

MAINT_MASK

The MAINT_MASK parameter will mask any of the failed conditions listed in MAINT_ENABLED. A bit on means that the condition is masked out from alarming and will not be reported.

MAINT_PRI

MAINT_PRI designates the alarming priority of the MAINT_ALM, "Process Alarms" on page 2-15. The default is 0 and the recommended values is 3 to 7.

MAINT_ACTIVE

The MAINT_ACTIVE parameter displays which of the alarms is active. Only the condition with the highest priority will be displayed. This priority is not the same as the MAINT_PRI parameter described above. This priority is hard coded within the device and is not user configurable.

MAINT_ALM

An alarm indicating the device needs maintenance soon. If the condition is ignored, the device will eventually fail.

Advisory Alarms

An advisory alarm indicates informative conditions that do not have a direct impact on the device's primary functions. There are five parameters associated with ADVISE_ALARMS, they are described below.

ADVISE_ENABLED

The ADVISE_ENABLED parameter contains a list of informative conditions that do not have a direct impact on the device's primary functions. Below is a list of the advisories with the highest priority first.

1. Process Anomaly Detected (SPM)
2. LOI Failure

ADVISE_MASK

The ADVISE_MASK parameter will mask any of the failed conditions listed in ADVISE_ENABLED. A bit on means the condition is masked out from alarming and will not be reported.

ADVISE_PRI

ADVISE_PRI designates the alarming priority of the ADVISE_ALM, see "Process Alarms" on page 2-15. The default is 0 and the recommended values are 1 or 2.

Model 3051S Series

ADVISE_ACTIVE

The ADVISE_ACTIVE parameter displays which of the advisories is active. Only the advisory with the highest priority will be displayed. This priority is not the same as the ADVISE_PRI parameter described above. This priority is hard coded within the device and is not user configurable.

ADVISE_ALM

ADVISE_ALM is an alarm indicating advisory alarms. These conditions do not have a direct impact on the process or device integrity.

Recommended Actions for PlantWeb Alarms

RECOMMENDED_ACTION

The RECOMMENDED_ACTION parameter displays a text string that will give a recommended course of action to take based on which type and which specific event of the PlantWeb alarms is active.

Table 2-1.
RB.RECOMMENDED_ACTION

Alarm Type	Failed/Maint/Advise Active Event	Recommended Action Text String
NONE	None	No action required
ADVISORY	LOI Failure	Check Display and Sensor connections
	Process Anomaly Detected (SPM)	Check the Statistical Process Monitor Status in the ADB Block
MAINTENANCE	Plugged Impulse Line Detected	Check the device Impulse Line(s)
	Secondary Value Degraded	The Instrument Body Temperature may be too Hot or too Cold. Confirm that it is within the Operating Range of the Transmitter
	Primary Value Degraded	The Instrument Pressure may be too High or too Low. Confirm that it is within the Operating Range of the Transmitter
	Sensor Module Memory Warning	Replace the Sensor Module at the next scheduled maintenance
FAILED	Sensor Module Memory Failure	Replace the Sensor Module
	Secondary Value Failure	Check the Interface Cable between the Sensor Module and the Fieldbus Electronics Board
	Primary Value Failure	Check the Interface Cable between the Sensor Module and the Fieldbus Electronics Board
	NV Memory Failure	Reset the Device then Download the Device Configuration
	Memory Failure	Replace the Fieldbus Electronics Board

SENSOR TRANSDUCER BLOCK

Before operating the transmitter, perform a Zero Trim and set the Damping.

NOTE

When the engineering units of the XD_SCALE are selected, the engineering units in the Transducer Block change to the same units. THIS IS THE ONLY WAY TO CHANGE THE ENGINEERING UNITS IN THE SENSOR TRANSDUCER BLOCK.

Zero Trim

⚠ Once the final installation of the transmitter has been completed, perform a Zero Trim before operating the transmitter. The Zero Trim procedure can be found in the Operation and Maintenance section.

Damping

⚠ The damping parameter in the Transducer Block may be used to filter measurement noise. By increasing the damping time, the transmitter will have a slower response time, but will decrease the amount of process noise that is translated to the Transducer Block Primary Value. Because both the LCD and AI Block get input from the Transducer Block, adjusting the damping parameter will effect both blocks.

NOTE

The AI Block has it's own filtering parameter called PV_FTME. For simplicity, it is better to do filtering in the Transducer Block as damping will be applied to primary value on every sensor update. If filtering is done in AI block, damping will be applied to output every macrocycle. The LCD will display value from Transducer block.

ANALOG INPUT (AI) FUNCTION BLOCK

Configure the AI block

⚠ A minimum of four parameters are required to configure the AI Block. The parameters are described below with example configurations shown at the end of this section.

CHANNEL

Select the channel that corresponds to the desired sensor measurement. The Model 3051S measures both pressure (channel 1) and sensor temperature (channel 2).

L_TYPE

The L_TYPE parameter defines the relationship of the sensor measurement (pressure or sensor temperature) to the desired output of the AI Block (e.g. pressure, level, flow, etc.). The relationship can be direct, indirect, or indirect square root.

Direct

Select direct when the desired output will be the same as the sensor measurement (pressure or sensor temperature).

Indirect

Select indirect when the desired output is a calculated measurement based on the sensor measurement (e.g. a pressure measurement is made to determine level in a tank). The relationship between the sensor measurement and the calculated measurement will be linear.

Model 3051S Series

Indirect Square Root

Select indirect square root when the desired output is an inferred measurement based on the sensor measurement and the relationship between the sensor measurement and the inferred measurement is square root (e.g. flow).

XD_SCALE and OUT_SCALE

The XD_SCALE and OUT_SCALE each include three parameters: 0%, 100%, and, engineering units. Set these based on the L_TYPE:

L_TYPE is Direct

When the desired output is the measured variable, set the XD_SCALE to represent the operating range of the process. Set OUT_SCALE to match XD_SCALE.

L_TYPE is Indirect

When an inferred measurement is made based on the sensor measurement, set the XD_SCALE to represent the operating range that the sensor will see in the process. Determine the inferred measurement values that correspond to the XD_SCALE 0 and 100% points and set these for the OUT_SCALE.

L_TYPE is Indirect Square Root

When an inferred measurement is made based on the sensor measurement AND the relationship between the inferred measurement and sensor measurement is square root, set the XD_SCALE to represent the operating range that the sensor will see in the process. Determine the inferred measurement values that correspond to the XD_SCALE 0 and 100% points and set these for the OUT_SCALE.

NOTE

To avoid configuration errors, only select Engineering Units for XD_SCALE and OUT_SCALE that are supported by the device. The supported units are:

Pressure (Channel 1)	Temperature (Channel 2)
Pa	°C
kPa	°F
bar	°K
mPa	
mbar	
torr	
atm	
psi	
g/cm2	
kg/cm2	
inH ₂ O at 68 °F	
mmH ₂ O at 68 °F	
in.H ₂ O at 4 °F	
mmH ₂ O at 4 °F	
ftH ₂ O at 68 °F	
inHg at 0 °C	
mmHg at 0 °C	

NOTE

When the engineering units of the XD_SCALE are selected, this causes the engineering units of the PRIMARY_VALUE_RANGE in the Transducer Block to change to the same units. THIS IS THE ONLY WAY TO CHANGE THE ENGINEERING UNITS IN THE SENSOR TRANSDUCER BLOCK, PRIMARY_VALUE_RANGE parameter.

Configuration Examples

Pressure transmitter

Situation #1

A pressure transmitter with a range of 0 – 100 psi.

Solution

Table 2-2 lists the appropriate configuration settings.

Table 2-2. Analog Input function block configuration for a typical pressure transmitter.

Parameter	Configured Values
L_TYPE	Direct
XD_SCALE	0 – 100 psi
OUT_SCALE	0 – 100 psi
Channel	1 - pressure

Pressure transmitter used to measure level in an open tank

Situation #2

The level of an open tank is to be measured using a pressure tap at the bottom of the tank. The maximum level at the tank is 16 ft. The liquid in the tank has a density that makes the maximum level correspond to a pressure of 7.0 psi at the pressure tap (see Figure 2-1).

Figure 2-1. Situation #2 Diagram.

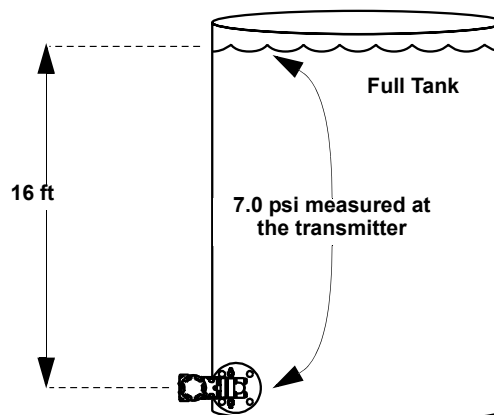

Solution to Situation #2

Table 2-3 lists the appropriate configuration settings.

Model 3051S Series

Table 2-3. Analog Input function block configuration for a pressure transmitter used in level measurement (situation #1).

Parameter	Configured Values
L_TYPE	Indirect
XD_SCALE	0 to 7 psi
OUT_SCALE	0 to 16 ft
Channel	1 - pressure

Output calculation for Situation #2

When the L_Type is configured as Indirect, the OUT parameter is calculated as:

$$OUT = \frac{PV - XD_SCALE_0\%}{XD_SCALE_100\% - XD_SCALE_0\%} * (OUT_SCALE_100\% - OUT_SCALE_0\%) + OUT_SCALE_0\%$$

In this example, when PV is 5 psi, then the OUT parameter will be calculated as follows:

$$OUT = \frac{5 \text{ psi} - 0 \text{ psi}}{7 \text{ psi} - 0 \text{ psi}} * (16 \text{ ft.} - 0 \text{ ft.}) + 0 \text{ ft.} = 11.43 \text{ ft.}$$

Situation #3

The transmitter in situation #3 is installed below the tank in a position where the liquid column in the impulse line, which an empty tank, is equivalent to 2.0 psi (see Figure 2-2).

Figure 2-2. Situation #3 Diagram.

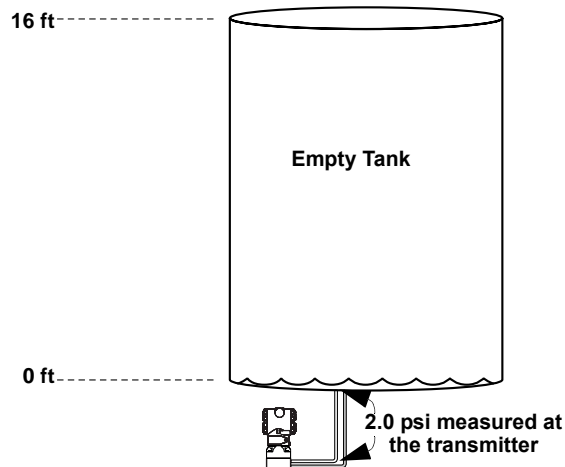

Solution to situation #3

Table 2-4 lists the appropriate configuration settings.

Table 2-4. Analog Input function block configuration for a pressure transmitter used in level measurement (Situation #3).

Parameter	Configured Values
L_TYPE	Indirect
XD_SCALE	2 to 9 psi
OUT_SCALE	0 to 16 ft
Channel	1 - pressure

In this example, when the PV is 4 psi, OUT will be calculated as follows:

$$OUT = 4 \text{ psi} - 2 \text{ psi} \cdot \frac{16 \text{ ft.} - 0 \text{ ft.}}{9 \text{ psi} - 2 \text{ psi}} + 0 \text{ ft.} = 4.57 \text{ ft.}$$

Differential pressure transmitter to measure flow

Situation #4

The liquid flow in a line is to be measured using the differential pressure across an orifice plate in the line. Based on the orifice specification sheet, the differential pressure transmitter was calibrated for 0 to 20 inH₂O for a flow of 0 to 800 gal/min.

Solution

Table 2-5 lists the appropriate configuration settings.

Table 2-5. Analog Input Function Block Configuration for a Differential Pressure Transmitter.

Parameter	Configured Values
L_TYPE	Indirect Square Root
XD_SCALE	0 to 20 in.H ₂ O
OUT_SCALE	0 to 800 gal/min.
Channel	1 - pressure

$$Out = \sqrt{\frac{PV - XDSCALE0}{XDSCALE100}} (OUTSCALE100 - OUTSCALE0) + OUTSCALE0$$

$$OUT = \sqrt{\frac{8 \text{ inH}_2\text{O} - 0 \text{ inH}_2\text{O}}{20 \text{ inH}_2\text{O} - 0 \text{ inH}_2\text{O}}} (800 \text{ gal/min.} - 0 \text{ gal/min.}) + 0 \text{ gal/min.} = 505.96 \text{ gal/min.}$$

Model 3051S Series

Filtering

⚠ The filtering feature changes the response time of the device to smooth variations in output readings caused by rapid changes in input. Adjust the filter time constant (in seconds) using the PV_FTIME parameter. Set the filter time constant to zero to disable the filter feature.

Figure 2-3. Analog Input PV_FTIME filtering Diagram.

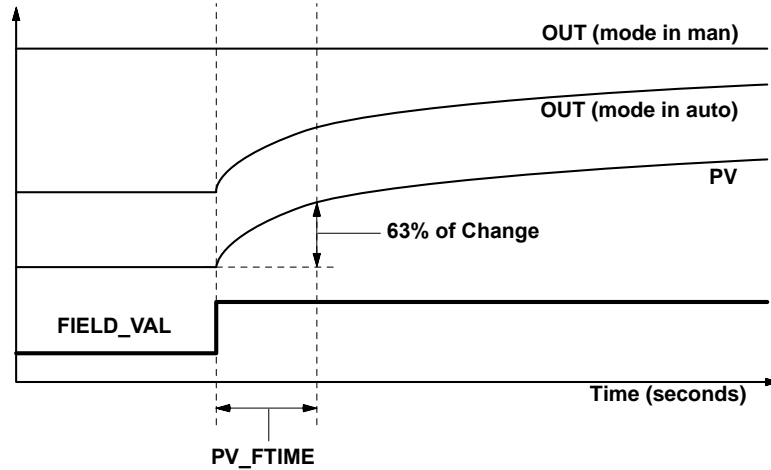

FIELDBUS-FBUS_03A

Low Cut

⚠ When the converted input value is below the limit specified by the LOW_CUT parameter, and the Low Cutoff I/O option (IO_OPTS) is enabled (True), a value of zero is used for the converted value (PV). This option is useful to eliminate false readings when the differential pressure measurement is close to zero, and it may also be useful with zero-based measurement devices such as flowmeters.

NOTE

Low Cutoff is the only I/O option supported by the AI block. Set the I/O option in **Manual** or **Out of Service** mode only.

Process Alarms

Process Alarm detection is based on the OUT value. Configure the alarm limits of the following standard alarms:

- High (HI_LIM)
- High high (HI_HI_LIM)
- Low (LO_LIM)
- Low low (LO_LO_LIM)

In order to avoid alarm chattering when the variable is oscillating around the alarm limit, an alarm hysteresis in percent of the PV span can be set using the ALARM_HYS parameter. The priority of each alarm is set in the following parameters:

- HI_PRI
- HI_HI_PRI
- LO_PRI
- LO_LO_PRI

Alarm Priority

Alarms are grouped into five levels of priority:

Priority Number	Priority Description
0	The alarm condition is not used.
1	An alarm condition with a priority of 1 is recognized by the system, but is not reported to the operator.
2	An alarm condition with a priority of 2 is reported to the operator.
3-7	Alarm conditions of priority 3 to 7 are advisory alarms of increasing priority.
8-15	Alarm conditions of priority 8 to 15 are critical alarms of increasing priority.

Status Options

Status Options (STATUS_OPTS) supported by the AI block are shown below:

Propagate Fault Forward

If the status from the sensor is Bad, Device failure or Bad, Sensor failure, propagate it to OUT without generating an alarm. The use of these sub-status in OUT is determined by this option. Through this option, the user may determine whether alarming (sending of an alert) will be done by the block or propagated downstream for alarming.

Uncertain if Limited

Set the output status of the Analog Input block to uncertain if the measured or calculated value is limited.

BAD if Limited

Set the output status to Bad if the sensor is violating a high or low limit.

Uncertain if Man Mode

Set the output status of the Analog Input block to uncertain if the actual mode of the block is Man.

NOTES

The instrument must be in **Out of Service** mode to set the status option.

Model 3051S Series

Advanced Features

The AI Function Block provides added capability through the addition of the following parameters:

ALARM_TYPE

ALARM_TYPE allows one or more of the process alarm conditions detected by the AI function block to be used in setting its OUT_D parameter.

OUT_D

OUT_D is the discrete output of the AI function block based on the detection of process alarm condition(s). This parameter may be linked to other function blocks that require a discrete input based on the detected alarm condition.

LCD TRANSDUCER BLOCK

The LCD meter connects directly to the Model 3051S electronics FOUNDATION fieldbus output board. The meter indicates output and abbreviated diagnostic messages.

The meter features a four-line display and a 0-100% scaled bar graph. The first line of five characters displays the output description, the second line of seven digits displays the actual value, the third line of six characters displays engineering units and the fourth line displays "Error" when the transmitter is in alarm. The LCD meter can also display diagnostic messages.

Each parameter configured for display will appear on the LCD for a brief period before the next parameter is displayed. If the status of the parameter goes bad, the LCD will also cycle diagnostics following the displayed variable:

Figure 2-4. LCD Messaging



Custom Meter Configuration

Shipped from the factory, Parameter #1 is configured to display the Primary Variable (pressure) from the LCD Transducer Block. Parameters 2 – 4 are not configured. To change the configuration of Parameter #1 or to configure additional parameters 2 – 4, use the configuration parameters below.

The LCD Transducer Block can be configured to sequence four different process variables as long as the parameters are sourced from a function block that is scheduled to execute within the Model 3051S pressure transmitter. If a function block is scheduled in the Model 3051S that links a process variable from another device on the segment, that process variable can be displayed on the LCD.

DISPLAY_PARAM_SEL

The DISPLAY_PARAM_SEL parameter specifies how many process variables will be displayed. Select up to four display parameters.

BLK_TAG_#⁽¹⁾

Enter the Block Tag of the function block that contains the parameter to be displayed. The default function block tags from the factory are:

TRANSDUCER
AI 1400
AI 1500
PID 1600
ISEL 1700
CHAR 1800
ARITH 1900
INTEG 2000

BLK_TYPE_#⁽¹⁾

Enter the Block Type of the function block that contains the parameter to be displayed. This parameter is generally selected via a drop-down menu with a list of possible function block types. (e.g. Transducer, PID, AI, etc.)

PARAM_INDEX_#⁽¹⁾

The PARAM_INDEX_# parameter is generally selected via a drop-down menu with a list of possible parameter names based upon what is available in the function block type selected. Choose the parameter to be displayed.

CUSTOM_TAG_#⁽¹⁾

The CUSTOM_TAG_# is an optional user-specified tag identifier that can be configured to be displayed with the parameter in place of the block tag. Enter a tag of up to five characters.

UNITS_TYPE_#⁽¹⁾

The UNITS_TYPE_# parameter is generally selected via a drop-down menu with three options: AUTO, CUSTOM, or NONE. Select AUTO only when the parameter to be displayed is pressure, temperature, or percent. For other parameters, select CUSTOM and be sure to configure the CUSTOM_UNITS_# parameter. Select NONE if the parameter is to be displayed without associated units.

CUSTOM_UNITS_#⁽¹⁾

Specify custom units to be displayed with the parameter. Enter up to six characters. To display Custom Units the UNITS_TYPE_# must be set to CUSTOM.

(1) _# represents the specified parameter number.

Model 3051S Series

Display bar graph

The Model 3051S LCD is equipped with a bar graph along the top portion of the display screen. The bar graph will display the percent of range of AI.OUT (see Figure 2-5) of the AI block configured for Channel 1 (pressure) of the Sensor Transducer Block.

The bar graph on the LCD can be enabled from the DISPLAY_PARAM_SEL parameter in the LCD block.

If no AI block is found to be configured for Channel 1 the bar graph (including annunciators) will remain blank. If more than one AI block is found to be configured for the Channel 1 the AI block with the lowest OD index will be used to calculate the bar graph value.

The following equation is used to calculate the percent of range of AI.OUT:

Figure 2-5. Bar Graph Value

$$\text{Bar Graph Value} = 100 * \frac{(\text{AI.OUT} - \text{AI.OUT_SCALE @ 0\%})}{(\text{AI.OUT_SCALE @ 100\%} - \text{AI.OUT_SCALE @ 0\%})}$$

If the bar graph value calculation returns a value less than 0%, the LCD will display a bar graph value of 0%.

If the bar graph value calculation returns a value greater than 100%, then the LCD will display a bar graph value of 100%.

ADVANCED DIAGNOSTICS TRANSDUCER BLOCK (ADB)

The Advanced Diagnostics Block (ADB) transducer block contains two different algorithms, Plugged Impulse Line Detection and Statistical Process Monitoring. Configuration, learning, and detection are the three different phases to the Plugged Impulse Line and Statistical Process Monitoring. The Advanced Diagnostics license must be purchased from Rosemount to use this feature, see "Advanced Diagnostics Block Licensing" on page 3-2.

ADB Parameters

For a complete listing of the Advanced Diagnostic Block (ADB) parameters see "Block Information" on page A-1.

Plugged Impulse Line Detection (PIL)

The PIL algorithm can detect a plugged impulse line of a gage pressure (GP) or absolute pressure (AP) transmitter. For Differential pressure (DP) transmitters it can detect either single impulse line or both impulse lines plugged. This is done by comparing process dynamics the algorithm has "Learned" to a set of "Detection" parameters that are configured by the user. Some of the parameter names may appear differently depending on your host system. Configuration learning, detection are the three different phases to the Plugged Impulse Line.

IMPORTANT

Plugged Impulse Line Detection is designed to be used in a continuous liquid flow application that is controlled by a set point.

The impulse lines should not be remote seal capillaries and they should be free from leaks.

**Configuration of the
Plugged Impulse Line
Detection**

Configuration Phase

The configuration phase is an inactive state. The configuration phase is used to set up the parameters controlling the sensitivity, thresholds, affect on PV_STATUS, length of the learning and detecting phases.

Learning Phase

The learning phase begins after a valid configuration is present. In the learning phase, the algorithm establishes a baseline of the process mean and process dynamics. This base line data is used to compare current process data to the base line when in the "Detection Phase".

Detection Phase

The detection phase begins after the learning phase is complete. To determine if the impulse lines are plugged, the algorithm compares the most recent mean and standard deviation of the process to the baseline mean and standard deviation.

To configure the PIL, open the ADB transducer block and refer to the host documentation. The three parameters below are the minimum required for configuration.

PLINE_Affect_PV_Status

PLINE_Affect_PV_Status determines whether the quality of the pressure measurement from the Sensor Transducer Block will be affected by the Plugged Impulse Line status. The parameter default is "false". When the algorithm detects plugged impulse lines there is no affect on the quality of the pressure measurement from the Sensor Transducer Block. If the parameter setting is "true", the ADB status will cause the quality of the pressure measurement from the Sensor Transducer Block to go "UNCERTAIN".

PLINE_Sensitivity

PLINE_Sensitivity determines the sensitivity of the PIL Detection Algorithm. Low sensitivity is primarily used if the process contains large amount of dynamics. Medium sensitivity would be recommended for normal processes. High sensitivity would be used for a process with minimal dynamics. Below is a guide for setting your "Plugging Sensitivity".

Sensitivity levels for all lines plugged used for DP, AP or GP:

- **Low sensitivity**
An 80% reduction in dynamics (with respect to the baseline dynamics) in the last detection cycle time (default 1 min.).
- **Medium sensitivity**
A 70% reduction in dynamics (with respect to the baseline dynamics) in the last detection cycle time (default 1 min.).
- **High sensitivity**
A 60% reduction in dynamics (with respect to the baseline dynamics) in the last detection cycle time (default 1 min.).

Model 3051S Series

Sensitivity levels for *one line plugged* used for DP only:

- **Low sensitivity**
A 100% increase in dynamics (with respect to the baseline dynamics) in the last detection cycle time (default 1 min.).
- **Medium sensitivity**
A 70% increase in dynamics (with respect to the baseline dynamics) in the last detection cycle time (default 1 min.).
- **High sensitivity**
A 40% increase in dynamics (with respect to the baseline dynamics) in the last detection cycle time (default 1 min.).

PLINE_ON

This parameter Enables or Disables the Plugged Impulse Line Algorithm. The PIL must be both licensed and activated in order to detect plugged impulse lines. The default state is disabled.

NOTE

For most applications the above parameters are all that are needed to configure the PIL for detection.

In order to use the Advanced Set of parameters below, fully understand the underlying technology of the PIL. These parameters will fine tune the PIL to fit process conditions.

Plugged Impulse Line Advanced Settings

PLINE_Relearn

PLINE_Relearn allows the user to activate the learning phase of the PIL Detection Algorithm. To activate, "Relearn" must be selected. This can be used to reinstate the algorithm after a plugged line has been detected. The proper measures must be taken to clear the plug, and the process should be running normally before relearning the process. Relearning the process may also be necessary after changing parameters in the Advanced Set of parameters.

PLINE_Auto Relearn

PLINE_Auto Relearn determines whether or not the algorithm automatically changes to learning mode when the thresholds are exceeded. When the default "Enabled" is selected the algorithm will automatically relearn when the mean value changes by more than the Relearn Threshold value. If "Disabled" is selected, relearn must be started manually, see "PLINE_Relearn" on page 2-20.

PLINE_Relearn Threshold

PLINE_Relearn Threshold is a percent value of URL of the transmitter range. If the mean has changed by this value and Auto Relearn is "Enabled", then the algorithm will automatically go into the learning state. If the Auto Relearn is "Disabled" this value is ignored. The default is 190 of the URL.

PLINE_Learning Cycle

PLINE_Learning Cycle determines the length of time the learning cycle uses to calculate the mean and standard deviation for the baseline. The default value is five minutes. If the process has a slow change in the mean over time, a longer learning cycle may provide a better baseline.

PLINE_Learn_Sensitivity

The PLINE_Learn_Sensitivity parameters provide very specific adjustments to the sensitivity during the learning phase.

- Insufficient Dynamics Check: Ignores the insufficient dynamic check if not selected. Use only when there is very low process noise. PIL may not detect a plugged line condition.
- 10%, 20%, and 30% Stdev. Change Check: Allows for 10, 20, or 30% change in Standard Deviation while in the learning state. If this value is exceeded, the algorithm will stay in the verifying state until the value is not exceeded.
- Three or six Sigma Mean Change Check: Allows for a three or six Sigma change in the mean while in the learning state. If this value is exceeded, algorithm will stay in the verifying state until the value is not exceeded.
- 2% Mean Change Check: The mean value of the baseline calculation can not vary more than 2% during the learning or verifying states. If this value is exceeded, algorithm will stay in the verifying state until the value is not exceeded.

PLINE_Detect_Length

PLINE_Detect_Length is the length of time the algorithm uses to take the process values and calculate the dynamics to compare to the learned baseline. This value should not be longer than the PLINE_LEARNING_LENGTH to avoid false detections. The default value is one minute. The detection cycle must be larger than the macrocycle of the system.

PLINE_Detect_Sensitivity

PLINE_Detect_Sensitivity will override the "Plugged Sensitivity" value. The values for this parameter are 0%-100% change in dynamics. Low values are used in low noise processes, and high values are used in noisy processes. This value is used when detecting two lines plugged condition for DP and line plugged for AP and GP transmitters.

PLINE_Single_Detect_Sensitivity

PLINE_Single_Detect_Sensitivity will override the Plugged Sensitivity value. The allowed values for this parameter are 0%-100% change in dynamics. Low values are used in low noise processes, and high values are used in noisy processes. This value is used when detecting single line plugged condition with DP transmitters only.

Statistical Process Monitoring (SPM)

Statistical Process Monitoring algorithm is intended to provide basic information regarding the behavior of process measurements such as PID control block and actual valve position. The algorithm can monitor up to four user selected variables. All variables must reside in a scheduled function block which is contained in the device. This algorithm can perform higher levels of diagnostics by distribution of computational power to field devices. The two statistical parameters monitored by the Statistical Process Monitoring are mean and standard deviation. By using the mean and standard deviation, the process or control levels and dynamics can be monitored for change over time. The algorithm also provides:

- Configurable limits/alarms for High variation, low dynamics, and mean changes with respect to the learned levels
- Necessary statistical information for Regulatory Control Loop Diagnostics, Root Cause Diagnostics, and Operations Diagnostics.

NOTE

In Fieldbus devices, a wealth of information is available to the user. Both process measurement and control is feasible at the device level. The devices themselves contain both the process measurements and control signals that are necessary to not only control the process, but to determine if the process and control is healthy. By looking at the process measurement data and control output over time, one can gain additional insight into the process. Under some load conditions and process demands, changes could be interpreted as degradation of instruments, valves or major components such as pumps, compressors, heat exchangers, etc.... This degradation may also indicate that the loop control scheme needs to be re-tuned or re-evaluated. By learning a healthy process and continually comparing current information to the known healthy information, problems due to degradation and eventual failure can be avoided and remedied ahead of time. These diagnostics are to aid in the engineering and maintenance of the devices. False alarms and missed detections may occur. If a reoccurring problem in your process exists, please contact Rosemount for assistance with the diagnostics.

Configuration Phase

The configuration phase is an inactive state when the SPM algorithm can be configured. In this phase, the block tags, block type, parameter, limits for high variation, low dynamics, and mean change detection can be set by the user. The “Statistical Process Monitoring Activation” parameter must be set to “disabled” to configure any SPM parameter. SPM can monitor any linkable input or output parameter of a scheduled function block that resides in the device.

Learning Phase

In the learning phase of Statistical Process Monitoring, the algorithm establishes a baseline of the mean and dynamics of a Statistical Process Monitoring variable. The baseline data is compared to current data for calculating any changes in mean or dynamics of the Statistical Process Monitoring variables.

Monitoring Phase

The monitoring phase starts after the learning process is complete. The algorithm compares the current values to the baseline values of the mean and standard deviation. During this phase the algorithm computes the percent change in mean and standard deviation to determine if the defined limits are violated.

SPM Configuration

SPM_Bypass_Verification

If “Yes” the verification of the baseline is turned off. If “No” the learned baseline is compared to the next current calculated value to ensure a good baseline value. The recommended value is NO.

SPM_Monitoring_Cycle

SPM_Monitoring_Cycle is the length of time the process values are taken and used in each calculation. A longer monitoring cycle may provide a more stable mean value. The default is 15 minutes.

SPM#_Block_Tag

Enter the Block Tag of the function block that contains the parameter to be monitored. Block tag must be entered, there is no pull-down menu to select the tag. The tag must be a valid “Block Tag” that is in the device. The default block tags from the factory are:

- AI 1400
- AI 1500
- PID 1600
- ISEL 1700
- CHAR 1800
- ARITH 1900
- INTEG 2000

SPM can also monitor “out” parameters from other devices. To do this, link the “out” parameter to an input parameter of a function block that resides in the device, and set up SPM to monitor the input parameter.

SPM#_Block Type

Enter the Block Type of the function block that contains the parameter to be monitored.

SPM#_Parameter Index

Enter the Parameter Index of the parameter to be monitored.

SPM#_Thresholds

The SPM#_Thresholds are used to allow alerts to be sent when the values are beyond the threshold values that have been set for each parameter.

Mean Limit

Alert Limit value in percent change of the Mean compared with the baseline mean value.

High Variation

Alert Limit value in percent change of the Stdev compared with the baseline Stdev value.

Low Dynamics

Alert Limit value in percent change of the Stdev compared with the baseline Stdev value.

SPM_Active

SPM_Active parameter that starts the Statistical Process Monitoring when “Enabled”. “Disabled” turns the diagnostic monitoring off. Must be set to “Disabled” for configuration. Only set to “Enabled” after fully configuring the SPM.

SPM#_User Command

Select “Learn” after all the parameters have been configured to begin the Learning Phase. The monitoring phase will start after the learning process is complete. Select “Quit” to stop the SPM “Detect” may be selected to return to the monitoring phase.

Baseline Values

The Baseline Values are the calculated values from the process over the Learning Cycle.

SPM#_Baseline_Mean

SPM#_Baseline_Mean is the calculated average of the process variable over the Learning Cycle.

SPM#_Baseline_Standard_Deviation

SPM#_Baseline_Standard_Deviation is the square root of the variance of the process variable over the Learning Cycle.

Section 3 Operation and Maintenance

Resource Block	page 3-2
Sensor Transducer Block	page 3-3
Analog Input (AI) Function Block	page 3-4
Advanced Diagnostics Transducer Block (ADB)	page 3-6

OVERVIEW

This section contains information on operation and maintenance procedures.

METHODS AND MANUAL OPERATION

Each FOUNDATION fieldbus host or configuration tool has different ways of displaying and performing operations. Some hosts will use Device Descriptions (DD) and DD Methods to complete device configuration and will display data consistently across platforms. The DD can found on www.rosemount.com. There is no requirement that a host or configuration tool support these features.

The information in this section will describe how to use methods in a general fashion. In addition, if your host or configuration tool does not support methods this section will cover manually configuring the parameters involved with each method operation. For more detailed information on the use of methods, see your host or configuration tool manual.

SAFETY MESSAGES

Procedures and instructions in this section may require special precautions to ensure the safety of the personnel performing the operations. Information that raises potential safety issues is indicated by a warning symbol (⚠). Refer to the following safety messages before performing an operation preceded by this symbol.

Warnings

⚠ WARNING

Explosions can result in death or serious injury.

- Do not remove the transmitter covers in explosive environments when the circuit is live.
- Transmitter covers must be fully engaged to meet explosion proof requirements.
- Before connecting a communicator in an explosive atmosphere, make sure the instruments in the loop are installed in accordance with intrinsically safe or nonincendive field wiring practices.

Model 3051S Series

WARNING

Electrical shock can result in death or serious injury.

- Avoid contact with the leads and terminals. High voltage that may be present on leads can cause electrical shock.

WARNING

Performing a 'Restart with defaults' will set all function block information in the device to factory defaults. This includes the clearing of all function block links and schedule, as well as defaulting all Resource and Transducer Block user data (Advanced Diagnostic Block algorithm configurations, LCD Transducer Block parameter configuration, etc.).

RESOURCE BLOCK

Advanced Diagnostics Block Licensing

 The Model 3051S has an optional Advanced Diagnostics Block (ADB) that can be configured to detect plugged impulse lines and monitor process statistics. If the ADB was not specified when the transmitter was ordered (option code D01 in the model number) a license can be purchased to activate this functionality. To license the ADB, run the upgrade device method.

1. Open the Resource Block and check the parameter DIAG_OPTIONS to determine whether or not the Plugged Impulse Line Detection (PIL) and Statistical Process Monitoring (SPM) have been licensed.
2. If PIL and SPM have not been licensed, open the Resource Block in the device and obtain the Output Board Serial Number (OUTPUT_BD_SN).
3. Call Rosemount Customer Central (1-800-999-9307) to place an order to obtain the license. The part number is 03031-0830-0001.
4. After placing the order, Technical Support will use the OUTPUT_BD_SN to generate an activation code that can be written to the device.
5. Set Resource Block to Out of Service (OOS).
6. Write the activation code to the fifth line of the parameter DEV_STRING. This parameter is found in the Resource Block.
7. Once the activation code has been written to the transmitter, perform a Master Reset on the Processor or power the device down and then bring it up again.
8. Return the Resource Block to Auto mode.

Master Reset Method

 To perform a master reset, run the Master Reset Method. If your system does not support methods, manually configure the Resource Block parameters listed below.

1. Set the RESTART to one of the options below:
 - Set Run to nominal state when not restarting (default)
 - Resource is not used by device”

 Defaults set all device parameters to FOUNDATION fieldbus default values

- The Processor does a software reset of the CPU

SENSOR TRANSDUCER BLOCK

Sensor Calibration, Upper and Lower Trim Methods

 In order to calibrate the transmitter, run the Upper and Lower Trim Methods. If your system does not support methods, manually configure the Transducer Block parameters listed below.

1. Set MODE_BLK.TARGET to OOS
2. Set CAL_UNIT to supported engineering units in the Transducer Block
3. Apply physical pressure that corresponds to the lower calibration point and allow the pressure to stabilize. The pressure must be between the range limits defined in PRIMARY_VALUE_RANGE.
4. Set values of CAL_POINT_LO to correspond to the pressure applied to the sensor.
5. Apply pressure, upper cal point.
6. Set CAL_POINT_HI

NOTE

CAL_POINT_HI must be within PRIMARY_VALUE_RANGE and greater than CAL_POINT_LO + CAL_MIN_SPAN

7. Set SENSOR_CAL_DATE to the current date.
8. Set SENSOR_CAL_WHO to the person responsible for the calibration.
9. Set SENSOR_CAL_LOC to the calibration location.
10. Set SENSOR_CAL_METHOD to User Trim
11. Set MODE_BLK.TARGET to AUTO

Model 3051S Series

Sensor Calibration, Zero Trim Method



In order to zero the transmitter, run the Zero Trim Method. If your system does not support methods, manually configure the Transducer Block parameters listed below.

1. Set MODE_BLK.TARGET to OOS
2. Apply zero pressure to the sensor and allow the to reading stabilize
3. Set values CAL_POINT_LO to 0
4. Set SENSOR_CAL_DATE to the current date.
5. Set SENSOR_CAL_WHO to the person responsible for the calibration.
6. Set SENSOR_CAL_LOC to the calibration location.
7. Set SENSOR_CAL_METHOD to User Trim
8. Set MODE_BLK.TARGET to AUTO

Factory Trim Recall Method



To perform a factory trim on the transmitter, run the Factory Trim Method. If your system does not support methods, manually configure the Transducer Block parameters listed below.

1. Set MODE_BLK.TARGET to OOS
2. Set FACTORY_CAL_RECALL to Recall
3. Set SENSOR_CAL_DATE to the current date.
4. Set SENSOR_CAL_WHO to the person responsible for the calibration.
5. Set SENSOR_CAL_LOC to the calibration location.
6. Set SENSOR_CAL_METHOD to Factory Trim
7. Set MODE_BLK.TARGET to AUTO

ANALOG INPUT (AI) FUNCTION BLOCK

STATUS

Along with the measured or calculated PV value, every FOUNDATION Fieldbus block passes an additional parameter called STATUS. The PV and STATUS are passed from the Transducer Block to the Analog Input Block. The STATUS can be one of the following: GOOD, BAD, or UNCERTAIN. When there are no problems detected by the self-diagnostics of the block, the STATUS will be GOOD. If a problem occurs with the hardware in the device, or, the quality of the process variable is compromised for some reason, the STATUS will become either BAD or UNCERTAIN depending upon the nature of the problem. It is important that the Control Strategy that makes use of the Analog Input Block is configured to monitor the STATUS and take action where appropriate when the STATUS is no longer GOOD.

Simulation

Simulate replaces the channel value coming from the Sensor Transducer Block. For testing purposes, it is possible to manually drive the output of the Analog Input Block to a desired value. There are two ways to do this.

Manual Mode

To change only the OUT_VALUE and not the OUT_STATUS of the AI Block, place the TARGET MODE of the block to MANUAL. Then, change the OUT_VALUE to the desired value.

Simulate

1. If the SIMULATE switch is in the OFF position, move it to the ON position. If the SIMULATE jumper is already in the ON position, you must move it to off and place it back in the ON position.

NOTE

As a safety measure, the switch must be reset every time power is interrupted to the device in order to enable SIMULATE. This prevents a device that is tested on the bench from getting installed in the process with SIMULATE still active.

2. To change both the OUT_VALUE and OUT_STATUS of the AI Block, set the TARGET MODE to AUTO.
3. Set SIMULATE_ENABLE_DISABLE to 'Active'.
4. Enter the desired SIMULATE_VALUE to change the OUT_VALUE and SIMULATE_STATUS_QUALITY to change the OUT_STATUS.

If errors occur when performing the above steps, be sure that the SIMULATE jumper has been reset after powering up the device.

Model 3051S Series

ADVANCED DIAGNOSTICS TRANSDUCER BLOCK (ADB)

Status of the Plugged Impulse Line

The Plugged Impulse Line contains the following status information:

Timestamp

Shows the timestamp of the last update to the Plugged Impulse Line Status.

PIL History Status

Current value of the Plugged Impulse Line Status. When there is no history there have been no plugged lines detected for this device.

Status	Meaning
OK	Algorithm is in the detection state.
Inactive	The algorithm is not enabled or a "Quit" command was issued.
Learning	Algorithm is currently learning the process characteristics.
Verifying	Algorithm is currently comparing the learned baseline with the current process.
Insufficient Dynamics	The process does not have enough dynamics to detect or the sensitivity is not set high enough, see page 3-6.
Bad PV Status	The Sensor Transducer Status is uncertain or Bad, therefore the algorithm is paused.
Not Licensed	The ADB is not currently purchased in this device.
Plugged Line	Algorithm has detected a plugged line condition. This could be either all lines plugged for DP, GP, and AP transmitters, or one line plugged for DP, GP and AP transmitters.

Monitoring and Status of the SPM

The Statistical Process Monitoring status includes the following monitoring and status information:

Monitoring

Baseline (SPM#_Mean and SPM# Standard Deviation)

Displays the Mean and Stdev values that were calculated during the learning state.

Monitoring (SPM#_Mean and SPM# Standard Deviation)

Current value that is calculated over the Monitoring Cycle.

Change (SPM#_Mean and SPM# Standard Deviation)

Value in percent that is calculated using the Monitoring and Baseline values. The alert thresholds are compared to this value to determine Mean change, High Variation and Low Dynamic detections.

Timestamp

Displays the time value for the recent detections.

Status

Shows the state that the diagnostic is currently in.

No Detections

Monitoring the process and no detections are currently active.

Inactive

User Command in "Idle", SPM not Enabled, or the block is not scheduled.

Learning

Learning has been set in the User Command, and the baseline values are being calculated

Verifying

Compares the learned values to the current calculated values to verify the process is stable.

Not Licensed

SPM is not currently purchased in this device.

Mean Change Detected

Alert resulting from the Mean Change exceeding the Threshold Mean Limit. Can be caused by a set point change, a load change in the flow, or an obstruction or the removal of an obstruction in the process.

High Variation Detected

Alert resulting from the Stdev Change exceeding the Threshold High Variation value.

Low Dynamics Detected

Alert resulting from the Stdev Change exceeding the Threshold Low Dynamics value. This is an indicator for a lower flow, or other change resulting in less turbulence in the flow.

Model 3051S FOUNDATION Fieldbus Supplement

00809-0200-4801, Rev AA

April 2002

Model 3051S Series

Section 4 Troubleshooting

Resource Block	page 4-5
Sensor Transducer Block	page 4-6
LCD Transducer block	page 4-7
Advanced Diagnostics Transducer Block (ADB)	page 4-8
Analog Input (AI) Function Block	page 4-7
Resource Block	page 4-5

OVERVIEW

This section provides summarized troubleshooting suggestions for the most common operating problems. This section contains Model 3051S fieldbus troubleshooting information only. Disassembly and reassembly procedures can be found in the Model 3051S manual, document 00809-0100-4801 located in the Troubleshooting.

Follow the procedures described here to verify that transmitter hardware and process connections are in good working order. Always deal with the most likely checkpoints first.

SAFETY MESSAGES

Procedures and instructions in this section may require special precautions to ensure the safety of the personnel performing the operations. Information that raises potential safety issues is indicated by a warning symbol (⚠). Refer to the following safety messages before performing an operation preceded by this symbol.

Warnings

⚠ WARNING

Explosions can result in death or serious injury.

- Do not remove the transmitter covers in explosive environments when the circuit is live.
- Transmitter covers must be fully engaged to meet explosion proof requirements.
- Before connecting a communicator in an explosive atmosphere, make sure that the instruments in the loop are installed according to intrinsically safe or nonincendive field wiring practices.

⚠ CAUTION

Static electricity can damage sensitive components.

- Observe safe handling precautions for static-sensitive components.

Model 3051S Series

TROUBLESHOOTING GUIDES

Figure 4-1. Model 3051S troubleshooting flowchart

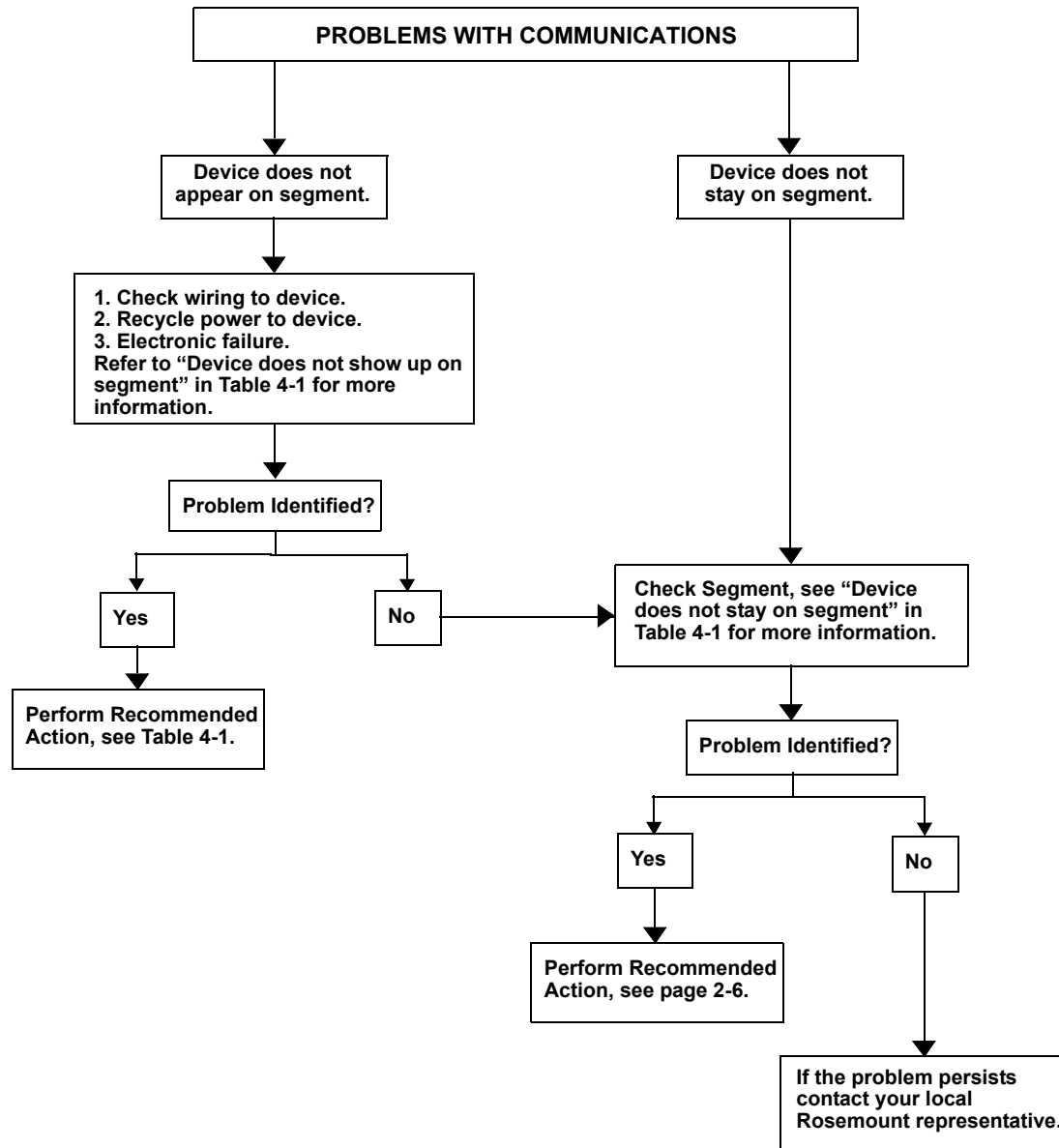

Model 3051S Series

Figure 4-2. Problems with communications flowchart

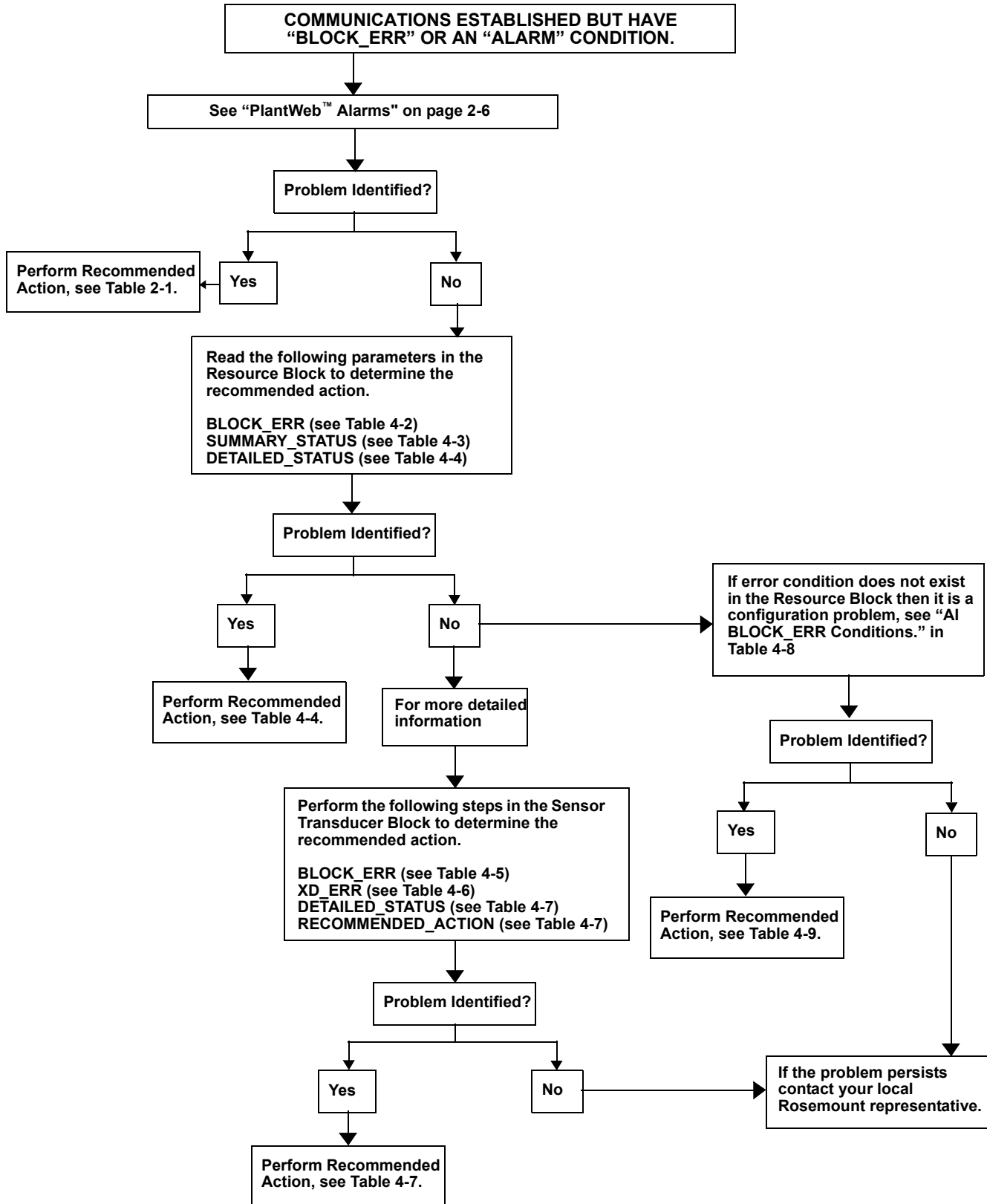

Model 3051S Series

Table 4-1. Troubleshooting guide.

Symptom ⁽¹⁾	Cause	Recommended Actions
Device does not show up on segment	Unknown	Recycle power to device
	No power to device	<ol style="list-style-type: none"> 1. Ensure the device is connected to the segment. 2. Check voltage at terminals. There should be 9–32Vdc. 3. Check to ensure the device is drawing current. There should be approximately 17 mA.
	Segment problems	
	Electronics failing	<ol style="list-style-type: none"> 1. Electronics board loose in housing. 2. Replace electronics.
	Incompatible network settings	Change host network parameters. Refer to host documentation for procedure.
Device does not stay on segment ⁽²⁾	Incorrect signal levels. Refer to host documentation for procedure.	<ol style="list-style-type: none"> 1. Check for two terminators. 2. Excess cable length. 3. Bad Power supply or conditioner
	Excess noise on segment. Refer to host documentation for procedure.	<ol style="list-style-type: none"> 1. Check for incorrect grounding. 2. Check for correct shielded wire. 3. Tighten wire connections. 4. Check for corrosion or moisture on terminals. 5. Check for Bad power supply.
	Electronics failing	<ol style="list-style-type: none"> 1. Tighten electronics board. 2. Replace electronics.
	Other	<ol style="list-style-type: none"> 1. Check for water in the terminal housing.

(1) The corrective actions should be done with consultation of your system integrator.

(2) Wiring and installation 31.25 kbit/s, voltage mode, wire medium application guide AG-140 available from the fieldbus Foundation.

Model 3051S Series

RESOURCE BLOCK

This section describes error conditions found in the Resource block. Read Table 4-2 through Table 4-4 to determine the appropriate corrective action.

Table 4-2. Resource Block BLOCK_ERR messages

Block Errors

Table 4-2 lists conditions reported in the BLOCK_ERR parameter.

Condition Name and Description
Other
Simulate Active: This indicates that the simulation switch is in place. This is not an indication that the I/O blocks are using simulated data.
Device Fault State Set
Device Needs Maintenance Soon
Memory Failure: A memory failure has occurred in FLASH, RAM, or EEPROM memory
Lost Static Data: Static data that is stored in non-volatile memory has been lost.
Lost NV Data: Non-volatile data that is stored in non-volatile memory has been lost.
Device Needs Maintenance Now
Out of Service: The actual mode is out of service.

Table 4-3. Resource Block SUMMARY_STATUS messages

Condition Name
Uninitialized
No repair needed
Repairable
Call Service Center

Table 4-4. Resource Block DETAILED_STATUS with recommended action messages

Condition Name	Recommended Action
LOI Transducer block error	<ol style="list-style-type: none"> 1. Restart processor 2. Check display connection 3. Call service center
Sensor Transducer block error.	<ol style="list-style-type: none"> 1. Restart processor 2. Check SuperModule™ cable 3. Call service center
Mfg. Block integrity error	<ol style="list-style-type: none"> 1. Restart processor 2. Call service center
Non-Volatile memory integrity error	<ol style="list-style-type: none"> 1. Restart processor 2. Call service center
ROM integrity error	<ol style="list-style-type: none"> 1. Restart processor 2. Call service center
ADB transducer block error	<ol style="list-style-type: none"> 1. Check impulse lines 2. Check anomaly detected (SPM) 3. Call service center

Model 3051S Series

SENSOR TRANSDUCER BLOCK

This section describes error conditions found in the Sensor Transducer Block. Read Table 4-5 through Table 4-7 to determine the appropriate corrective action.

Table 4-5. Sensor Transducer Block BLOCK_ERR messages

Condition Name and Description
Other
Out of Service: The actual mode is out of service.

Table 4-6. Sensor Transducer Block XD_ERR messages

Condition Name and Description
Electronics Failure: An electrical component failed.
I/O Failure: An I/O failure occurred.
Data Integrity Error: Data stored in the device is no longer valid due to a non-volatile memory checksum failure, a data verify after write failure, etc.
Algorithm Error: The algorithm used in the transducer block produced an error due to overflow, data reasonableness failure, etc.

Diagnostics

Table 4-7 lists the potential errors and the possible corrective actions for the given values. The corrective actions are in order of increasing system level compromises. The first step should always be to reset the transmitter and then if the error persists, try the steps in Table 4-7. Start with the first corrective action and then try the second.

Table 4-7. Sensor Transducer Block DETAILED_XD_STATUS and RECOMMENDED_ACTION messages

Condition Name and Description	RECOMMENDED_ACTION
Pressure sensor not updating	1. Restart Processor 2. Reconnect SuperModule cable 3. Send to Service Center
Temperature sensor not updating	1. Restart Processor 2. Reconnect SuperModule cable 3. Send to Service Center
Sensor ROM Check sum failure	1. Restart Processor 2. Send to Service Center
Sensor NV write failure	1. Restart Processor 2. Send to Service Center
Sensor RAM check sum error	1. Restart Processor 2. Send to Service Center
Sensor NV factory data warning	1. Restart Processor 2. Send to Service Center
Sensor NV user data warning	1. Restart Processor 2. Send to Service Center
Sensor NV user data error	1. Restart Processor 2. Send to Service Center
Sensor NV factory data error	1. Restart Processor 2. Send to Service Center
Pressure sensor out of limits	1. Check pressure 2. Restart Processor
Sensor temperature out of limits	1. Check Temperature 2. Restart Processor
Sensor temperature beyond failure limits	1. Check Temperature 2. Restart Processor 3. Send to Service Center

Model 3051S Series

ANALOG INPUT (AI) FUNCTION BLOCK

This section describes error conditions that are supported by the AI Block. Read Table 4-9 to determine the appropriate corrective action.

Table 4-8. AI BLOCK_ERR Conditions.

Condition Number	Condition Name and Description
0	Other
1	Block Configuration Error: the selected channel carries a measurement that is incompatible with the engineering units selected in XD_SCALE, the L_TYPE parameter is not configured, or CHANNEL = zero.
3	Simulate Active: Simulation is enabled and the block is using a simulated value in its execution.
7	Input Failure/Process Variable has Bad Status: The hardware is bad, or a bad status is being simulated.
14	Power Up
15	Out of Service: The actual mode is out of service.

Table 4-9. Troubleshooting the AI block

Symptom	Possible Causes	Recommended Actions
Bad or no pressure readings (Read the AI "BLOCK_ERR" parameter)	BLOCK_ERR reads OUT OF SERVICE (OOS)	1. AI Block target mode target mode set to OOS. 2. Resource Block OUT OF SERVICE.
	BLOCK_ERR reads CONFIGURATION ERROR	1. Check CHANNEL parameter (see "CHANNEL" on page 2-9) 2. Check L_TYPE parameter (see "L_TYPE" on page 2-9) 3. Check XD_SCALE engineering units. (see "XD_SCALE and OUT_SCALE" on page 2-10)
	BLOCK_ERR reads POWERUP	Download Schedule into block. Refer to host for downloading procedure.
	BLOCK_ERR reads BAD INPUT	1. Sensor Transducer Block Out Of Service (OOS) 2. Resource Block Out of Service (OOS)
	No BLOCK_ERR but readings are not correct. If using Indirect mode, scaling could be wrong.	1. Check XD_SCALE parameter. 2. Check OUT_SCALE parameter. (see "XD_SCALE and OUT_SCALE" on page 2-10)
	No BLOCK_ERR. Sensor needs to be calibrated or Zero trimmed.	See Section 3: Operation and Maintenance to determine the appropriate trimming or calibration procedure.
OUT parameter status reads UNCERTAIN and substatus reads EngUnitRangViolation.	Out_ScaleEU_0 and EU_100 settings are incorrect.	See "XD_SCALE and OUT_SCALE" on page 2-10.

Model 3051S Series

LCD TRANSDUCER BLOCK

This section describes error conditions found in the LCD Transducer Block. Read Table 4-10 and to determine the appropriate corrective action.

Self Test Procedure for the LCD

The SELF_TEST parameter in the Resource block will test LCD segments. When running, the segments of the display should light up for about five seconds.

If your host system supports methods refer to your host documentation on how to run the "Self Test" method. If your host system does not support methods than you can run this test manually be following the steps below.

1. Put Resource block into "OOS" (Out of Service).
2. Go to the parameter called "SELF_TEST" and write the value Self test (0x2).
3. Observe the LCD screen when you are doing this. All of the segments should light up.
4. Put the Resource block back into "AUTO".

Table 4-10. LCD Transducer Block BLOCK_ERR messages

Condition Name and Description
Other
Out of Service: The actual mode is out of service.

Symptom	Possible Causes	Recommended Action
The LCD displays "DSPLY#INVALID." Read the BLOCK_ERR and if it says "BLOCK CONFIGURATION" perform the Recommended Action	One or more of the display parameters are not configured properly.	See "LCD Transducer Block" on page 2-16.
The Bar Graph and the AI.OUT readings do not match.	The OUT_SCALE of the AI block is not configured properly.	See "Analog Input (AI) Function Block" on page 2-9 and "Display bar graph" on page 2-18.
"3051" is being displayed or not all of the values are being displayed.	The LCD block parameter "DISPLAY_PARAMETER_SELECT is not properly configured.	See "LCD Transducer Block" on page 2-16.
The display reads OOS	The resource and or the LCD Transducer block are OOS.	Verify that both blocks are in "AUTO,"
The display is hard to read.	Some of the LCD segments may have gone bad. Device is out of the temperature limit for the LCD. (-20 to 80 °C)	See XXXX (Self Test). If some of the segment is bad, replace the LCD. Check ambient temperature of the device.

Model 3051S Series

ADVANCED DIAGNOSTICS TRANSDUCER BLOCK (ADB)

This section describes error conditions found in the LCD Transducer Block. Read Table 4-11 to determine the appropriate corrective action.

Table 4-11. Advanced Diagnostic Block BLOCK_ERR messages

Condition Name and Description
Other
Out of Service: The actual mode is out of service.

Symptom	Possible Causes	Recommended Action
PIL or SPM will not go to Learning, read the Status of the algorithm. If the Status reads "Inactive" read the Possible Causes to determine the recommended action.	ADB Block is not licensed. The algorithm Status should also say "Not Licensed."	1. Check DIAG_OPTIONS in the Resource Block. PIL/SPM or a hex value of 0x00000300 should be shown. See "Advanced Diagnostics Block Licensing" on page 3-2 to license the ADB block.
	Resource Block Actual Mode is OOS.	Determine why the Resource block is in OOS. Correct problem then put Resource Block into Auto mode
	ADB block Actual mode is OOS.	Put ADB block into Auto mode.
	The algorithms were not activated.	To activate either of the algorithms see page 2-18.
	The SPM (only) algorithm was not configured properly.	1. Configure at least one of the monitoring variables properly, see "SPM Configuration" on page 2-23.
	For the SPM algorithm only: The variable to be monitored is in an unscheduled function block	Download a schedule into the function block. Consult your host documentation for downloading schedules.
PIL Status reads "Insufficient Dynamics."	For SPM (only), the block in which the process variable is coming from is not in Auto mode.	Put monitored block into Auto mode.
	There is not enough process noise or there is no flow in the line.	1. Check to see if the process is flowing. 2. Your process may have low process dynamics. You can turn off this check. This should only be done after a careful thought process, see "PLINE_Sensitivity" on page 2-19.
The PIL Status stay in Verifying.	The process dynamics are not stable.	Ensure that the process flow is stable.
	The PIL algorithm is not properly configured.	The process may be varying by more than the algorithm is configured for. Adjust the learning sensitivity to compensate for this, see "PLINE_Sensitivity" on page 2-19.
The PIL Status reads "Bad PV Status"	There is a problem in the Sensor Transducer Block.	See "Model 3051S troubleshooting flowchart" on page 4-2.

Model 3051S Series

Appendix A Block Information

Resource Block	page A-1
Sensor Transducer Block	page A-5
Analog Input (AI) Function Block	page A-8
LCD Transducer Block	page A-12
Advanced Diagnostics Transducer Block (ADB)	page A-13

OVERVIEW

Figure A-1. Analog Input Function Block Schematic

RESOURCE BLOCK

This section contains information on the Model 3051S Resource Block. Descriptions of all Resource Block Parameters, errors, and diagnostics are included. Also the modes, alarm detection, status handling, and troubleshooting are discussed.

Definition

The resource block defines the physical resources of the device. The resource block also handles functionality that is common across multiple blocks. The block has no linkable inputs or outputs.



Model 3051S Series

Parameters and Descriptions

The table below lists all of the configurable parameters of the Resource Block, including the descriptions and index numbers for each.

Parameter	Index Number	Description
ACK_OPTION	38	Selection of whether alarms associated with the function block will be automatically acknowledged.
ADVISE_ACTIVE	82	Enumerated list of advisory conditions within a device.
ADVISE_ALM	83	Alarm indicating advisory alarms. These conditions do not have a direct impact on the process or device integrity.
ADVISE_ENABLE	80	Enabled ADVISE_ALM alarm conditions. Corresponds bit for bit to the ADVISE_ACTIVE. A bit on means that the corresponding alarm condition is enabled and will be detected. A bit off means the corresponding alarm condition is disabled and will not be detected.
ADVISE_MASK	81	Mask of ADVISE_ALM. Corresponds bit of bit to ADVISE_ACTIVE. A bit on means that the condition is masked out from alarming.
ADVISE_PRI	79	Designates the alarming priority of the ADVISE_ALM
ALARM_SUM	37	The current alert status, unacknowledged states, unreported states, and disabled states of the alarms associated with the function block.
ALERT_KEY	04	The identification number of the plant unit.
BLOCK_ALM	36	The block alarm is used for all configuration, hardware, connection failure or system problems in the block. The cause of the alert is entered in the subcode field. The first alert to become active will set the Active status in the Status parameter. As soon as the Unreported status is cleared by the alert reporting task, another block alert may be reported without clearing the Active status, if the subcode has changed.
BLOCK_ERR	06	This parameter reflects the error status associated with the hardware or software components associated with a block. It is a bit string, so that multiple errors may be shown.
CLR_FSAFE	30	Writing a Clear to this parameter will clear the device FAIL_SAFE if the field condition has cleared.
CONFIRM_TIME	33	The time the resource will wait for confirmation of receipt of a report before trying again. Retry will not happen when CONFIRM_TIME=0.
CYCLE_SEL	20	Used to select the block execution method for this resource. The Model 3051S supports the following: Scheduled: Blocks are only executed based on the function block schedule. Block Execution: A block may be executed by linking to another blocks completion.
CYCLE_TYPE	19	Identifies the block execution methods available for this resource.
DD_RESOURCE	09	String identifying the tag of the resource which contains the Device Description for this resource.
DD_REV	13	Revision of the DD associated with the resource - used by an interface device to locate the DD file for the resource.
DEFINE_WRITE_LOCK	60	Allows the operator to select how WRITE_LOCK behaves. The initial value is "lock everything". If the value is set to "lock only physical device" then the resource and transducer blocks of the device will be locked but changes to function blocks will be allowed.
DETAILED_STATUS	55	Indicates the state of the transmitter. See Resource Block detailed status codes.
DEV_REV	12	Manufacturer revision number associated with the resource - used by an interface device to locate the DD file for the resource.
DEV_STRING	43	This is used to load new licensing into the device. The value can be written but will always read back with a value of 0.
DEV_TYPE	11	Manufacturer's model number associated with the resource - used by interface devices to locate the DD file for the resource.
DIAG_OPTION	46	Indicates which diagnostics licensing options are enabled.
DISTRIBUTOR	42	Reserved for use as distributor ID. No Foundation enumerations defined at this time.
DOWNLOAD_MODE	67	Gives access to the boot block code for over-the-wire downloads. 0 = Uninitialized 1 = Run mode 2 = Download mode

Model 3051S FOUNDATION Fieldbus Supplement

00809-0200-4801, Rev AA

April 2002

Model 3051S Series

Parameter	Index Number	Description
FAIL_SAFE	28	Condition set by loss of communication to an output block, fault promoted to an output block or physical contact. When FAIL_SAFE condition is set, then output function blocks will perform their FAIL_SAFE actions.
FAILED_ACTIVE	72	Enumerated list of failure conditions within a device.
FAILED_ALM	73	Alarm indicating a failure within a device which makes the device non-operational.
FAILED_ENABLE	70	Enabled FAILED_ALM alarm conditions. Corresponds bit for bit to the FAILED_ACTIVE. A bit on means that the corresponding alarm condition is enabled and will be detected. A bit off means the corresponding alarm condition is disabled and will not be detected.
FAILED_MASK	71	Mask of FAILED_ALM. Corresponds bit of bit to FAILED_ACTIVE. A bit on means that the condition is masked out from alarming.
FAILED_PRI	69	Designates the alarming priority of the FAILED_ALM.
FB_OPTION	45	Indicates which function block licensing options are enabled.
FEATURES	17	Used to show supported resource block options. See Error! Reference source not found. The supported features are: SOFT_WRITE_LOCK_SUPPORT, HARD_WRITE_LOCK_SUPPORT, REPORTS, and UNICODE
FEATURES_SEL	18	Used to select resource block options.
FINAL_ASSY_NUM	54	The same final assembly number placed on the neck label.
FREE_SPACE	24	Percent of memory available for further configuration. Zero in a preconfigured device.
FREE_TIME	25	Percent of the block processing time that is free to process additional blocks.
GRANT_DENY	14	Options for controlling access of host computers and local control panels to operating, tuning, and alarm parameters of the block. Not used by device.
HARD_TYPES	15	The types of hardware available as channel numbers.
HARDWARE_REV	52	Hardware revision of the hardware that has the resource block in it.
ITK_VER	41	Major revision number of the inter operability test case used in certifying this device as interoperable. The format and range are controlled by the Fieldbus Foundation.
LIM_NOTIFY	32	Maximum number of unconfirmed alert notify messages allowed.
MAINT_ACTIVE	77	Enumerated list of maintenance conditions within a device.
MAINT_ALM	78	Alarm indicating the device needs maintenance soon. If the condition is ignored, the device will eventually fail.
MAINT_ENABLE	75	Enabled MAINT_ALM alarm conditions. Corresponds bit for bit to the MAINT_ACTIVE. A bit on means that the corresponding alarm condition is enabled and will be detected. A bit off means the corresponding alarm condition is disabled and will not be detected.
MAINT_MASK	76	Mask of MAINT_ALM. Corresponds bit of bit to MAINT_ACTIVE. A bit on means that the condition is masked out from alarming.
MAINT_PRI	74	Designates the alarming priority of the MAINT_ALM
MANUFAC_ID	10	Manufacturer identification number – used by an interface device to locate the DD file for the resource.
MAX_NOTIFY	31	Maximum number of unconfirmed notify messages possible.
MEMORY_SIZE	22	Available configuration memory in the empty resource. To be checked before attempting a download.
MESSAGE_DATE	57	Date associated with the MESSAGE_TEXT parameter.
MESSAGE_TEXT	58	Used to indicate changes made by the user to the device's installation, configuration, or calibration.
MIN_CYCLE_T	21	Time duration of the shortest cycle interval of which the resource is capable.
MISC_OPTION	47	Indicates which miscellaneous licensing options are enabled.
MODE_BLK	05	The actual, target, permitted, and normal modes of the block: Target: The mode to “go to” Actual: The mode the “block is currently in” Permitted: Allowed modes that target may take on Normal: Most common mode for actual
NV_CYCLE_T	23	Minimum time interval specified by the manufacturer for writing copies of NV parameters to non-volatile memory. Zero means it will never be automatically copied. At the end of NV_CYCLE_T, only those parameters which have changed need to be updated in NVRAM.
OUTPUT_BOARD_SN	53	Output board serial number.

Model 3051S Series

Parameter	Index Number	Description
RB_SFTWR_REV_ALL	51	The string will contains the following fields: Major rev: 1-3 characters, decimal number 0-255 Minor rev: 1-3 characters, decimal number 0-255 Build rev: 1-5 characters, decimal number 0-255 Time of build: 8 characters, xx:xx:xx, military time Day of week of build: 3 characters, Sun, Mon,... Month of build: 3 characters, Jan, Feb. Day of month of build: 1-2 characters, decimal number 1-31 Year of build: 4 characters, decimal Builder: 7 characters, login name of builder
RB_SFTWR_REV_BUILD	50	Build of software that the resource block was created with.
RB_SFTWR_REV_MAJOR	48	Major revision of software that the resource block was created with.
RB_SFTWR_REV_MINOR	49	Minor revision of software that the resource block was created with.
RECOMMENDED_ACTION	68	Enumerated list of recommended actions displayed with a device alert.
RESTART	16	Allows a manual restart to be initiated. Several degrees of restart are possible. They are the following: 1 Run – nominal state when not restarting 2 Restart resource – not used 3 Restart with defaults – set parameters to default values. See START_WITH_DEFAULTS below for which parameters are set. 4 Restart processor – does a warm start of CPU.
RS_STATE	07	State of the function block application state machine.
SAVE_CONFIG_BLOCKS	62	Number of EEPROM blocks that have been modified since last burn. This value will count down to zero when the configuration is saved.
SAVE_CONFIG_NOW	61	Allows the user to optionally save all non-volatile information immediately.
SECURITY_IO	65	Status of security switch.
SELF_TEST	59	Instructs resource block to perform self-test. Tests are device specific.
SET_FSAFE	29	Allows the FAIL_SAFE condition to be manually initiated by selecting Set.
SHED_RCAS	26	Time duration at which to give up on computer writes to function block RCas locations. Shed from RCas shall never happen when SHED_ROUT = 0
SHED_ROUT	27	Time duration at which to give up on computer writes to function block ROut locations. Shed from ROut shall never happen when SHED_ROUT = 0
SIMULATE_IO	64	Status of simulate switch.
SIMULATE_STATE	66	The state of the simulate switch: 0 = Uninitialized 1 = Switch off, simulation not allowed 2 = Switch on, simulation not allowed (need to cycle jumper/switch) 3 = Switch on, simulation allowed
ST_REV	01	The revision level of the static data associated with the function block.
START_WITH_DEFAULTS	63	0 = Uninitialized 1 = do not power-up with NV defaults 2 = power-up with default node address 3 = power-up with default pd_tag and node address 4 = power-up with default data for the entire communications stack (no application data)
STRATEGY	03	The strategy field can be used to identify grouping of blocks.
SUMMARY_STATUS	56	An enumerated value of repair analysis.
TAG_DESC	02	The user description of the intended application of the block.
TEST_RW	08	Read/write test parameter - used only for conformance testing.
UPDATE_EVT	35	This alert is generated by any change to the static data.
WRITE_ALM	40	This alert is generated if the write lock parameter is cleared.
WRITE_LOCK	34	If set, no writes from anywhere are allowed, except to clear WRITE_LOCK. Block inputs will continue to be updated.
WRITE_PRI	39	Priority of the alarm generated by clearing the write lock.
XD_OPTION	44	Indicates which transducer block licensing options are enabled.

SENSOR TRANSDUCER BLOCK

The transducer block contains the actual measurement data, including a pressure and temperature reading. The transducer block includes information about sensor type, engineering units, linearization, reranging, temperature compensation, and diagnostics.

Parameters and Descriptions

Parameter	Index Number	Description	Notes on how changing this parameter effects transmitter operation.
ALERT_KEY	04	The identification number of the plant unit.	No effect on operation of transmitter but may affect the way alerts are sorted on the host end.
BLOCK_ALM	08	The block alarm is used for all configuration, hardware, connection failure or system problems in the block. The cause of the alert is entered in the subcode field. The first alert to become active will set the Active status in the Status parameter. As soon as the Unreported status is cleared by the alert reporting task, another block alert may be reported without clearing the Active status, if the subcode has changed.	No effect.
BLOCK_ERR	06	This parameter reflects the error status associated with the hardware or software components associated with a block. It is a bit string, so that multiple errors may be shown.	No effect.
CAL_MIN_SPAN	18	The minimum calibration span value allowed. This minimum span information is necessary to ensure when calibration is done, the two calibrated points are not too close together.	No effect.
CAL_POINT_HI	16	The highest calibrated value.	Assigns a value to the calibration high point.
CAL_POINT_LO	17	The lowest calibrated value.	Assigns a value to the calibration low point.
CAL_UNIT	19	The device description engineering units code index for the calibration values.	Device must be calibrated using the appropriate engineering units.
COLLECTION_DIRECTORY	12	A directory that specifies the number, starting indices, and DD Item ID's of the data collections in each transducer.	No effect.
DRAIN_VENT_MTL	42	Indicates the type of material that the drain vents on the flange are made of. See Drain Vent Material Codes.	
FACTORY_CAL_RECALL	32	Recalls the sensor calibration set at the factory.	
FLANGE_MTL	36	Indicates the type of material that the flange is made of. See Flange Material Codes.	
FLANGE_TYPE	35	Indicates the type of flange that is attached to the device. See Flange Type Codes.	
MODE_BLK	05	The actual, target, permitted, and normal modes of the block. Target: The mode to "go to" Actual: The mode the "block is currently in" Permitted: Allowed modes that target may take on Normal: Most common mode for target	Assigns the device mode.
MODULE_TYPE	33	Indicates the type of sensor module.	
O_RING_MTL	41	Indicates the type of material that the flange o-rings are made of. See O-ring Material Codes.	
PRIMARY_VALUE	14	The measured value and status available to the function block.	No effect.
PRIMARY_VALUE_DAMPING	43	Time constant of a single exponential filter for the PV, in seconds.	

Model 3051S Series

Parameter	Index Number	Description	Notes on how changing this parameter effects transmitter operation.
PRIMARY_VALUE_RANGE	15	The high and low range limit values, the engineering unit code, and the number of digits to the right of the decimal point to be used to display the final value. Valid engineering units are the following: 1130 = Pa 1133 = kPa 1137 = bar 1138 = mbar 1139 = torr 1140 = atm 1141 = psi 1144 = g/cm ² 1145 = kg/cm ² 1148 = inH ₂ O @ 68 °F 1151 = mmH ₂ O @ 68 °F 1154 = ftH ₂ O @ 68 °F 1156 = inHg @ 0 °C 1158 = mmHg @ 0 °C	No effect.
PRIMARY_VALUE_TYPE	13	Type of measurement represented by the primary value. 107 = Differential pressure 108 = Gage pressure 109 = Absolute pressure	No effect.
REM_SEAL_FILL	40	Indicates the type of fill fluid used in the remote seals. See Remote Seal Fill Fluid Codes.	
REM_SEAL_ISO_MTL	39	Indicates the type of material that the remote seal isolators are made of. See Remote Seal Isolator Material Codes.	
REM_SEAL_NUM	37	Indicates the number of remote seals that are attached to the device. See Remote Seal Number Codes.	
REM_SEAL_TYPE	38	Indicates the type of remote seals that are attached to the device. See Remote Seal Type Codes.	
SECONDARY_VALUE	29	The secondary value, related to the sensor.	No effect.
SECONDARY_VALUE_UNIT	30	Engineering units to be used with SECONDARY_VALUE. 1001 °C 1002 °F	No effect.
SENSOR_CAL_DATE	25	The last date on which the calibration was performed. This is intended to reflect the calibration of that part of the sensor that is usually wetted by the process.	No effect.
SENSOR_CAL_LOC	24	The last location of the sensor calibration. This describes the physical location at which the calibration was performed.	No effect.
SENSOR_CAL_METHOD	23	The method of last sensor calibration.	No effect.
SENSOR_CAL_TYPE	34	The type of last sensor calibration.	No effect.
SENSOR_CAL_WHO	26	The name of the person responsible for the last sensor calibration.	No effect.
SENSOR_FILL_FLUID	28	Defines the type of fill fluid used in the sensor.	No effect.
SENSOR_ISOLATOR_MTL	27	Defines the construction material of the isolating diaphragms.	No effect.
SENSOR_RANGE	21	The high and low range limit values, the engineering units code, and the number of digits to the right of the decimal point for the sensor.	No effect.
SENSOR_SN	22	Serial number of the sensor.	No effect.

Model 3051S FOUNDATION Fieldbus Supplement

00809-0200-4801, Rev AA

April 2002

Model 3051S Series

Parameter	Index Number	Description	Notes on how changing this parameter effects transmitter operation.
SENSOR_TYPE	20	Type of sensor connected with the transducer block.	No effect.
ST_REV	01	The revision level of the static data associated with the function block.	No effect.
STRATEGY	03	The strategy field can be used to identify grouping of blocks.	No effect.
TAG_DESC	02	The user description of the intended application of the block.	No effect.
TB_DETAILED_STATUS	31	Indicates the state of the transmitter. The parameter contains specific codes relating to the transducer block and the pressure sensor specifically.	No effect.
TRANSDUCER_DIRECTORY	09	Directory that specifies the number and starting indices of the transducers in the transducer block.	No effect.
TRANSDUCER_TYPE	10	Identifies the transducer that follows.	No effect.
UPDATE_EVT	07	This alert is generated by any change to the static data.	No effect.
XD_ERROR	11	Provides additional error codes related to transducer blocks.	No effect.

Model 3051S Series

ANALOG INPUT (AI) FUNCTION BLOCK

The Analog Input (AI) function block processes field device measurements and makes them available to other function blocks. The output value from the AI block is in engineering units and contains a status indicating the quality of the measurement. The measuring device may have several measurements or derived values available in different channels. Use the channel number to define the variable that the AI block processes.

The AI block supports alarming, signal scaling, signal filtering, signal status calculation, mode control, and simulation. In Automatic mode, the block's output parameter (OUT) reflects the process variable (PV) value and status. In Manual mode, OUT may be set manually. The Manual mode is reflected on the output status. A discrete output (OUT_D) is provided to indicate whether a selected alarm condition is active. Alarm detection is based on the OUT value and user specified alarm limits. Figure A-1 illustrates the internal components of the AI function block, and Table A-1 lists the AI block parameters and their units of measure, descriptions, and index numbers.

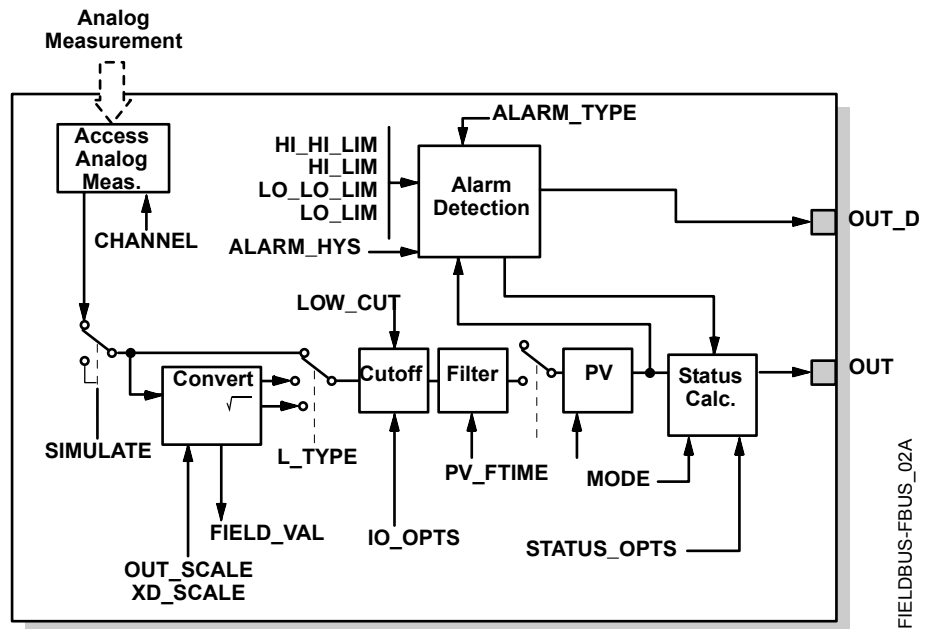

NOTES:
 OUT = block output value and status.
 OUT_D = discrete output that signals a selected alarm condition.

AI Parameter Table

Table A-1. Definitions of Analog Input Function Block System Parameters.

Parameter	Index No.	Available Values	Units	Default	Read/Write	Description
ACK_OPTION	23	0 = Auto Ack Disabled 1 = Auto Ack Enabled	None	0 all Disabled	Read and Write	Used to set auto acknowledgment of alarms.
ALARM_HYS	24	0 – 50	Percent	0.5	Read and Write	The amount the alarm value must return within the alarm limit before the associated active alarm condition clears.
ALARM_SEL	38	HI_HI, HI, LO, LO_LO	None	Non selected	Read and Write	Used to select the process alarm conditions that will cause the OUT_D parameter to be set.
ALARM_SUM	22	Enable/Disable	None	Enable	Read and Write	The summary alarm is used for all process alarms in the block. The cause of the alert is entered in the subcode field. The first alert to become active will set the Active status in the Status parameter. As soon as the Unreported status is cleared by the alert reporting task, another block alert may be reported without clearing the Active status, if the subcode has changed.
ALERT_KEY	04	1 – 255	None	0	Read and Write	The identification number of the plant unit. This information may be used in the host for sorting alarms, etc.
BLOCK_ALM	21	Not applicable	None	Not applicable	Read only	The block alarm is used for all configuration, hardware, connection failure or system problems in the block. The cause of the alert is entered in the subcode field. The first alert to become active will set the Active status in the Status parameter. As soon as the Unreported status is cleared by the alert reporting task, another block alert may be reported without clearing the Active status, if the subcode has changed.
BLOCK_ERR	06	Not applicable	None	Not applicable	Read only	This parameter reflects the error status associated with the hardware or software components associated with a block. It is a bit string, so that multiple errors may be shown.
CAP_STDDEV	40	> = 0	Seconds	0	Read and Write	The time over which the VAR_INDEX is evaluated.
CHANNEL	15	1 = Pressure 2 = Housing temperature	None	AI ⁽¹⁾ : Channel = 1 AI2: Channel = 2	Read and Write	The CHANNEL value is used to select the measurement value. Refer to the appropriate device manual for information about the specific channels available in each device. You must configure the CHANNEL parameter before you can configure the XD_SCALE parameter.
FIELD_VAL	19	0 – 100	Percent	Not applicable	Read only	The value and status from the transducer block or from the simulated input when simulation is enabled.
GRANT_DENY	12	Program Tune Alarm Local	None	Not applicable	Read and Write	Normally the operator has permission to write to parameter values, but Program or Local remove that permission and give it to the host controller or a local control panel.
HI_ALM	34	Not applicable	None	Not applicable	Read only	The HI alarm data, which includes a value of the alarm, a timestamp of occurrence and the state of the alarm.
HI_HI_ALM	33	Not applicable	None	Not applicable	Read only	The HI HI alarm data, which includes a value of the alarm, a timestamp of occurrence and the state of the alarm.
HI_HI_LIM	26	Out_Scale ⁽²⁾	Out_Scale ⁽²⁾	Not applicable	Read and Write	The setting for the alarm limit used to detect the HI HI alarm condition.
HI_HI_PRI	25	0 – 15	None	1	Read and Write	The priority of the HI HI alarm.
HI_LIM	28	Out_Scale ⁽²⁾	Out_Scale ⁽²⁾	Not applicable	Read and Write	The setting for the alarm limit used to detect the HI alarm condition.
HI_PRI	27	0 – 15	None	1	Read and Write	The priority of the HI alarm.
IO_OPTS	13	Low Cutoff Enable/Disable	None	Disable	Read and Write	Allows the selection of input/output options used to alter the PV. Low cutoff enabled is the only selectable option.

Model 3051S Series

Parameter	Index No.	Available Values	Units	Default	Read/Write	Description
L_TYPE	16	Direct Indirect Indirect Square Root	None	Direct	Read and Write	Linearization type. Determines whether the field value is used directly (Direct), is converted linearly (Indirect), or is converted with the square root (Indirect Square Root).
LO_ALM	35	Not applicable	None	Not applicable	Read only	The LO alarm data, which includes a value of the alarm, a timestamp of occurrence and the state of the alarm.
LO_LIM	30	Out_Scale ⁽²⁾	Out_Scale ⁽²⁾	Not applicable	Read and Write	The setting for the alarm limit used to detect the LO alarm condition.
LO_LO_ALM	36	Not applicable	None	Not applicable	Read only	The LO LO alarm data, which includes a value of the alarm, a timestamp of occurrence and the state of the alarm.
LO_LO_LIM	32	Out_Scale ⁽²⁾	Out_Scale ⁽²⁾	Not applicable	Read and Write	The setting for the alarm limit used to detect the LO LO alarm condition.
LO_LO_PRI	31	0 – 15	None	1	Read and Write	The priority of the LO LO alarm.
LO_PRI	29	0 – 15	None	1	Read and Write	The priority of the LO alarm.
LOW_CUT	17	> = 0	Out_Scale ⁽²⁾	0	Read and Write	If percentage value of transducer input fails below this, PV = 0.
MODE_BLK	05	Auto Manual Out of Service	None	Not applicable	Read and Write	The actual, target, permitted, and normal modes of the block. Target: The mode to “go to” Actual: The mode the “block is currently in” Permitted: Allowed modes that target may take on Normal: Most common mode for target
OUT	08	Out_Scale ⁽²⁾ ± 10%	Out_Scale ⁽²⁾	Not applicable	Read and Write	The block output value and status.
OUT_D	37	Discrete_State 1 – 16	None	Disabled	Read and Write	Discrete output to indicate a selected alarm condition.
OUT_SCALE	11	Any output range	All available	none	Read and Write	The high and low scale values, engineering units code, and number of digits to the right of the decimal point associated with OUT.
PV	07	Not applicable	Out_Scale ⁽²⁾	Not applicable	Read only	The process variable used in block execution.
PV_FTIME	18	> = 0	Seconds	0	Read and Write	The time constant of the first-order PV filter. It is the time required for a 63% change in the IN value.
SIMULATE	09	Not applicable	None	Disable	Read and Write	A group of data that contains the current transducer value and status, the simulated transducer value and status, and the enable/disable bit.
ST_REV	01	Not applicable	None	0	Read only	The revision level of the static data associated with the function block. The revision value will be incremented each time a static parameter value in the block is changed.
STATUS_OPTS	14	Propagate fault forward Uncertain if Limited Bad if Limited Uncertain if Man Mode		0	Read and Write	
STDDEV	39	0 – 100	Percent	0	Read and Write	The average absolute error between the PV and its previous mean value over that evaluation time defined by VAR_SCAN.
STRATEGY	03	0 – 65535	None	0	Read and Write	The strategy field can be used to identify grouping of blocks. This data is not checked or processed by the block.

Model 3051S FOUNDATION Fieldbus Supplement

00809-0200-4801, Rev AA

April 2002

Model 3051S Series

Parameter	Index No.	Available Values	Units	Default	Read/Write	Description
TAG_DESC	02	32 text characters	None	none	Read and Write	The user description of the intended application of the block.
UPDATE_EVT	20	Not applicable	None	Not applicable	Read only	This alert is generated by any change to the static data.
XD_SCALE	10	Any sensor range	inH ₂ O (68 °F) inHg (0 °C) ftH ₂ O (68 °F) mmH ₂ O (68 °F) mmHg (0 °C) psi bar mbar g/cm ² kg/cm ² Pa kPa torr atm deg C deg F	AI1 ⁽¹⁾ : Customer specification or inH ₂ O (68 °F) for DP/GP rng 1, 2, 3) or psi for DP/GP rng 4, 5 AP/3051T all rng AI2 deg C		In all Rosemount devices the units of the transducer block is forced to match the unit code.

(1) The host system may write over default values pre-configured by Rosemount Inc.

(2) Assume that when L_Type = Direct, the user configures Out_Scale which is equal to XD_Scale

Model 3051S Series

LCD TRANSDUCER BLOCK

Parameter	Index	Description
ALERT_KEY	4	The identification number of the plant unit.
BLK_TAG_1	15	The tag of the block containing DP1.
BLK_TAG_2	21	The tag of the block containing DP2.
BLK_TAG_3	27	The tag of the block containing DP3.
BLK_TAG_4	33	The tag of the block containing DP4.
BLK_TYPE_1	14	The enumerated block type for DP1's block.
BLK_TYPE_2	20	The enumerated block type for DP2's block.
BLK_TYPE_3	26	The enumerated block type for DP3's block.
BLK_TYPE_4	32	The enumerated block type for DP4's block.
BLOCK_ALM	8	The BLOCK_ALM is used for all configuration, hardware, connection failure or system problems in the block. The cause of the alert is entered in the subcode field. The first alert to become active will set the Active status in the Status attribute. As soon as the Unreported status is cleared by the alert reporting task, another block alert may be reported without clearing the Active status, if the subcode has changed.
BLOCK_ERR	6	This parameter reflects the error status associated with the hardware or software components associated with a block. it is a bit string, so that multiple errors may be shown.
COLLECTION_DIRECTORY	12	A directory that specifies the number, starting indices, and DD Item ID's of the data collections in each transducer block.
CUSTOM_TAG_2	23	The block description that is displayed for DP2.
CUSTOM_TAG_3	29	The block description that is displayed for DP3.
CUSTOM_TAG_4	35	The block description that is displayed for DP4.
CUSTOM_TAG_1	17	The block description that is displayed for DP1.
CUSTOM_UNITS_2	25	This is the user entered units that are displayed when UNITS_TYPE_2=Custom.
CUSTOM_UNITS_3	31	This is the user entered units that are displayed when UNITS_TYPE_3=Custom.
CUSTOM_UNITS_4	37	This is the user entered units that are displayed when UNITS_TYPE_4=Custom.
CUSTOM_UNITS_1	19	This is the user entered units that are displayed when UNITS_TYPE_1=Custom.
DISPLAY_PARAM_SEL	13	This will determine which Display Parameters are active. Bit 0 = DP1 Bit 1 = DP2 Bit 2 = DP3 Bit 3 = DP4 Bit 4 = Bar Graph enable
MODE_BLK	5	The actual, target, permitted, and normal modes of the block.
PARAM_INDEX_1	16	The relative index of DP1 within its block.
PARAM_INDEX_2	22	The relative index of DP2 within its block.
PARAM_INDEX_3	28	The relative index of DP3 within its block.
PARAM_INDEX_4	34	The relative index of DP4 within its block.
ST_REV	1	The revision level of the static data associated with the function block.
STRATEGY	3	The strategy field can be used to identify grouping of blocks.
TAG_DESC	2	The user description of the intended application of the block.
TRANSDUCER_DIRECTORY	9	A directory that specifies the number and starting indices of the transducers in the transducer block.
TRANSDUCER_TYPE	10	Identifies the transducer that follows.
UNITS_TYPE_1	18	This parameter determines where the units for the display parameter come from.
UNITS_TYPE_2	24	This parameter determines where the units for the display parameter come from.
UNITS_TYPE_3	30	This parameter determines where the units for the display parameter come from.
UNITS_TYPE_4	36	This parameter determines where the units for the display parameter come from.
UPDATE_EVT	7	This alert is generated by any change to the static data.
XD_ERROR	11	Provides additional error codes related to transducer blocks.

**ADVANCED
DIAGNOSTICS
TRANSDUCER BLOCK
(ADB)**

Table A-2. ADB parameter table

Parameter	Index	Description
ADB_STATUS	13	ADB status.
ALERT_KEY	4	The identification number of the plant unit.
BLOCK_ALM	8	The BLOCK_ALM is used for all configuration, hardware, connection failure or system problems in the block. The cause of the alert is entered in the subcode field. The first alert to become active will set the Active status in the Status attribute. As soon as the Unreported status is cleared by the alert reporting task, another block alert may be reported without clearing the Active status, if the subcode has changed.
BLOCK_ERR	6	This parameter reflects the error status associated with the hardware or software components associated with a block. it is a bit string, so that multiple errors may be shown.
COLLECTION_DIRECTORY	12	A directory that specifies the number, starting indices, and DD Item ID's of the data collections in each transducer block.
DIAG_EVT	14	Diagnostic event
MODE_BLK	5	The actual, target, permitted, and normal modes of the block.
ST_REV	1	The revision level of the static data associated with the function block.
STRATEGY	3	The strategy field can be used to identify grouping of blocks.
TAG_DESC	2	The user description of the intended application of the block.
TRANSDUCER_DIRECTORY	9	A directory that specifies the number and starting indices of the transducers in the transducer block.
TRANSDUCER_TYPE	10	Identifies the transducer that follows.
UPDATE_EVT	7	This alert is generated by any change to the static data.
XD_ERROR	11	Provides additional error codes related to transducer blocks.

Statistical Process Monitoring Algorithm		
Parameter	Index	Description
SPM_ACTIVE	15	Enables/Disables the Statistical Process Monitoring algorithm
SPM_BYPASS_VERIFICATION	17	Enables/Disables Bypass of Process Stability Checks during Learning
SPM_MONITORING_CYCLE	16	Baseline length and frequency of Mean and Stdev updates
SPM1_BASELINE_MEAN	28	Baseline Mean for SPM1
SPM1_BASELINE_STDEV	29	Baseline Stdev for SPM1
SPM1_BLOCK_TAG	19	Block tag for the process variable
SPM1_BLOCK_TYPE	18	The function block type for the SPM variable
SPM1_HIGH_VARIATION_LIM	31	Percent increase in dynamics for SPM1 allowed by user
SPM1_LOW_DYNAMICS_LIM	32	Percent decrease in dynamics for SPM1 allowed by user
SPM1_MEAN	24	Last Mean of SPM1
SPM1_MEAN_CHANGE	25	Percent change in SPM1 Mean with respect to Baseline Mean
SPM1_MEAN_LIM	30	Percent change in mean for SPM1 allowed by user
SPM1_PARAM_INDEX	20	OD Parameter index for the Block Tag that is entered.
SPM1_STATUS	21	Status of the SPM1 Statistical Process Monitoring
SPM1_STDEV	26	Last Stdev of SPM1
SPM1_STDEV_CHANGE	27	Change in SPM1 Stdev with respect to Baseline Stdev
SPM1_TIMESTAMP	22	Timestamp of last SPM1 Statistical Process Monitoring status change
SPM1_USER_COMMAND	23	User control for the Statistical Process Monitoring session.
SPM2_BASELINE_MEAN	43	Baseline Mean for SPM2
SPM2_BASELINE_STDEV	44	Baseline Stdev for SPM2
SPM2_BLOCK_TAG	34	Block tag for the process variable

Model 3051S Series

SPM2_BLOCK_TYPE	33	The function block type for the SPM variable
SPM2_HIGH_VARIATION_LIM	46	Percent increase in dynamics for SPM2 allowed by user
SPM2_LOW_DYNAMICS_LIM	47	Percent increase in dynamics for SPM2 allowed by user
SPM2_MEAN	39	Last Mean of SPM2
SPM2_MEAN_CHANGE	40	Percent change in SPM2 Mean with respect to Baseline Mean
SPM2_MEAN_LIM	45	Percent change in mean for SPM2 allowed by user
SPM2_PARAM_INDEX	35	OD Parameter index for the Block Tag that is entered.
SPM2_STATUS	36	Status of the SPM2 Statistical Process Monitoring
SPM2_STDEV	41	Last Stdev of SPM2
SPM2_STDEV_CHANGE	42	Change in SPM2 Stdev with respect to Baseline Stdev
SPM2_TIMESTAMP	37	Timestamp of last SPM2 Statistical Process Monitoring status change
SPM2_USER_COMMAND	38	User control for the Statistical Process Monitoring session.
SPM3_BASELINE_MEAN	58	Baseline Mean for SPM3
SPM3_BASELINE_STDEV	59	Baseline Stdev for SPM3
SPM3_BLOCK_TAG	49	Block tag for the process variable
SPM3_BLOCK_TYPE	48	The function block type for the SPM variable
SPM3_HIGH_VARIATION_LIM	61	Percent increase in dynamics for SPM3 allowed by user
SPM3_LOW_DYNAMICS_LIM	62	Percent decrease in dynamics for SPM3 allowed by user
SPM3_MEAN	54	Last Mean of SPM3
SPM3_MEAN_CHANGE	55	Percent change in SPM3 Mean with respect to Baseline Mean
SPM3_MEAN_LIM	60	Percent change in mean for SPM3 allowed by user
SPM3_PARAM_INDEX	50	OD Parameter index for the Block Tag that is entered.
SPM3_STATUS	51	Status of the SPM3 Statistical Process Monitoring
SPM3_STDEV	56	Last Stdev of SPM3
SPM3_STDEV_CHANGE	57	Change in SPM3 Stdev with respect to Baseline Stdev
SPM3_TIMESTAMP	52	Timestamp of last SPM3 Statistical Process Monitoring status change
SPM3_USER_COMMAND	53	User control for the Statistical Process Monitoring session.
SPM4_BASELINE_MEAN	73	Baseline Mean for SPM4
SPM4_BASELINE_STDEV	74	Baseline Stdev for SPM4
SPM4_BLOCK_TAG	64	Block tag for the process variable
SPM4_BLOCK_TYPE	63	The function block type for the SPM variable
SPM4_HIGH_VARIATION_LIM	76	Percent increase in dynamics for SPM4 allowed by user
SPM4_LOW_DYNAMICS_LIM	77	% Decrease in dynamics for SPM4 allowed by user
SPM4_MEAN	69	Last Mean of SPM4
SPM4_MEAN_CHANGE	70	Percent change in SPM4 Mean with respect to Baseline Mean
SPM4_MEAN_LIM	75	Percent change in mean for SPM4 allowed by user
SPM4_PARAM_INDEX	65	OD Parameter index for the Block Tag that is entered.
SPM4_STATUS	66	Status of the SPM4 Statistical Process Monitoring
SPM4_STDEV	71	Last Stdev of SPM4
SPM4_STDEV_CHANGE	72	Change in SPM4 Stdev with respect to Baseline Stdev
SPM4_TIMESTAMP	67	Timestamp of last SPM4 Statistical Process Monitoring status change
SPM4_USER_COMMAND	68	User control for the Statistical Process Monitoring session.

Plugged Impulse Line Algorithm		
Parameter	Index	Description
PLINE_AFFECT_PV_STATUS	83	Determines whether the quality of the pressure measurement will be affected or unaffected
PLINE_AUTO_RELEARN	88	Enables/Disables Auto Relearn on Process Mean Changes
PLINE_DETECT_LENGTH	87	Length of Detection Cycle Status Update in Minutes
PLINE_DETECT_SENSITIVITY	91	Overrides IL Plugging Sensitivity if a non-zero value is entered. Value corresponds to a percentage decrease in standard deviation.
PLINE_HISTORY_STATUS	84	Last plugged Line determination status
PLINE_HISTORY_TIMESTAMP	85	Previous plugged Line determination timestamp
PLINE_LEARN_LENGTH	86	Length of Learning and Verification Cycles in Minutes
PLINE_LEARN_SENSITIVITY	90	Learning Sensitivity Check Options. Only one of bits 2, 3 and 4 is allowed and only one of bits 5 and 6 is allowed.
PLINE_ON	80	Turns algorithm On/Off
PLINE_RELEARN	81	Resets the algorithm and re initiates learning
PLINE_RELEARN_THRESHOLD	89	Threshold for Relearning in%URL of Sensor (excludes Range 1 and 2 DP...Those thresholds are fixed at 2 and 5 inH2O)
PLINE_SENSITIVITY	82	Detection Sensitivity
PLINE_SINGLE_DETECT_SENSITIVITY	92	Overrides IL Plugging Sensitivity if a non-zero value is entered. Value corresponds to a percentage increase in standard deviation. (Used by DP transmitters only)
PLINE_STATUS	78	Last Impulse line status
PLINE_TIMESTAMP	79	Last Timestamp for PLINE_STATUS

Model 3051S Series

Index

A

Address 1-2
 Temporary Node 1-2
 Advanced Diagnostics Transducer Block (ADB) 1-2, 2-18, 3-6, 4-8, A-13
 Block Error 4-8
 Licensing 3-2
 Operation and Maintenance . 3-6
 Parameters A-13
 Troubleshooting 4-8
 Advanced Features 2-15
 ADVISE_ACTIVE 2-8
 ADVISE_ALM 2-8
 ADVISE_ENABLED 2-7
 ADVISE_MASK 2-7
 ADVISE_PRI 2-7
 Advisory Alarms 2-7
 ADVISE_ACTIVE 2-8
 ADVISE_ALM 2-8
 ADVISE_MASK 2-7
 ADVISE_PRI 2-7
 AI Block. See Analog Input (AI) Function Block
 Alarm Priority 2-15
 ALARM_TYPE 2-16
 Alarms
 ADVISE_ACTIVE 2-8
 ADVISE_ALM 2-8
 ADVISE_MASK Parameter
 ADVISE_MASK 2-7
 ADVISE_PRI 2-7
 Advisory 2-7
 ALARM_TYPE 2-16
 FAILED_ACTIVE 2-6
 FAILED_ALARMS 2-6
 FAILED_ALM 2-6
 FAILED_ENABLED 2-6
 FAILED_MASK 2-6
 FAILED_PRI 2-6
 MAINT_ACTIVE 2-7
 MAINT_ALARMS 2-6
 MAINT_ALM 2-7
 MAINT_ENABLED 2-7
 MAINT_MASK 2-7
 MAINT_PRI 2-7
 PlantWeb 2-6, 2-8
 Priority 2-15
 Process 2-15

Analog Input (AI) block A-8
 Analog Input (AI) Function Block . 1-3, 2-9, 4-7, A-8
 ALARM_TYPE 2-16
 Block Information A-8
 BLOCK_ERR 4-7
 Configuration 2-9
 IO_OPTS 2-14
 LOW_CUT 2-14
 OUT_D 2-16
 Parameters A-9
 PV_FTIME 2-14
 Status 2-15
 Troubleshooting 4-7

Approvals 1-1
 Arithmetic Block 1-3

B

BAD if Limited 2-15
 Bar graph 2-18
 Baseline Values 2-24
 BLK_TAG_# 2-17
 BLK_TYPE_# 2-17
 Block Errors 4-7
 Block Information 1-1
 BLOCK_ERR
 AI Block 4-7
 Resource Block 4-5

C

Capabilities 2-4
 Block Execution Times 2-4
 Host Timer 2-4
 VCRs 2-4
 Changing Modes 2-2
 Channel 2-9, 2-10
 Configuration 1-1, 2-1
 Advanced Diagnostics Transducer Block (ADB) 2-18
 Analog Input (AI) Function Block 2-9
 XD_SCALE,
 OUT_SCALE 2-10
 Channel 2-9
 Custom Meter 2-16
 Direct 2-10
 Examples 2-11

L_TYPE 2-9
 Direct 2-9
 Indirect 2-9, 2-10
 Indirect Square Root 2-10
 LCD Transducer Block 2-16
 Plugged Impulse
 Line Detection 2-19
 Resource Block 2-4
 Statistical Process Monitoring (SPM) 2-22
 Custom meter configuration 2-16
 CUSTOM_TAG_# 2-17
 CUSTOM_UNITS_# 2-17

D

Damping 2-9
 Device Description 1-2
 Direct 2-9, 2-10
 DISPLAY_PARAM_SEL 2-16

E

Examples, Configuration 2-11
 Differential Pressure 2-13
 Pressure Open Tank 2-11
 Typical Pressure 2-11
 Execution Times 2-4

F

FAILED_ACTIVE alarms 2-6
 FAILED_ALARMS 2-6
 FAILED_ACTIVE 2-6
 FAILED_ALM 2-6
 FAILED_ENABLED 2-6
 FAILED_MASK 2-6
 FAILED_PRI 2-6
 FAILED_ALM 2-6
 FAILED_ENABLED alarms 2-6
 FAILED_MASK alarms 2-6
 FAILED_PRI alarms 2-6
 FEATURES
 FEATURES_SEL 2-5
 Features 2-4
 Advanced 2-15
 FEATURES, FEATURES_SEL 2-4
 Features 2-4
 Reports 2-4
 Soft W Lock, Hard W Lock 2-5



Model 3051S Series

Unicode	2-4	LOW_CUT		P	
Filtering	2-14	AI block	2-14	PARAM_INDEX_#	2-17
AI block	2-14	Lower Trim Method	3-3	Parameter	
Foundation fieldbus				Advanced Diagnostics Transducer	
function blocks	1-2			Block (ADB)	A-13
FREE_SPACE	2-3			ADVISE_ACTIVE	2-8
				ADVISE_ALM	2-8
G		M		ADVISE_ENABLED	2-7
General Block Information		MAINT_ACTIVE	2-7	ADVISE_PRI	2-7
Block Instantiation	2-2	MAINT_ALARMS	2-6	ALARM_TYPE	2-16
Capabilities	2-2	MAINT_ACTIVE	2-7	Analog Input (AI)	
Link Active Scheduler	2-2	MAINT_ALM	2-7	Function Block	A-9
Modes	2-2	MAINT_ENABLED	2-7	Baseline Values	2-24
		MAINT_MASK	2-7	SPM#_Baseline_Mean	2-24
		MAINT_PRI	2-7	SPM#_Baseline_Standard_D	
H		MAINT_ALM	2-7	eviation	2-24
HI_HI_LIM	2-15	MAINT_ENABLED	2-7	BLK_TAG_#	2-17
HI_HI_PRI	2-15	MAINT_MASK	2-7	BLK_TYPE_#	2-17
HI_LIM	2-15	MAINT_PRI	2-7	BLOCK_ERR	4-5, 4-7
HI_PRI	2-15	Manual Mode	3-5	CHANNEL	2-9
High Variation	2-24	Manual Operation	3-1	CUSTOM_TAG_#	2-17
		Master Reset Method	3-3	CUSTOM_UNITS_#	2-17
		MAX_NOTIFY	2-5	DEFINE_WRITE_LOCK	2-5
		LIM_NOTIFY	2-5	DISPLAY_PARAM_SEL	2-16
		Mean Limit	2-24	FAILED_ACTIVE	2-6
		Methods	3-1	FAILED_ALARMS	2-6
		MODE_BLK.TARGET	2-2	FAILED_ALM	2-6
		MODE_BLOCK.ACTUAL	2-2	FAILED_ENABLED	2-6
		Modes		FAILED_MASK	2-6
		Changing Modes	2-2	FAILED_PRI	2-6
		Permitted Modes	2-2	FEATURES	2-4
		Types of Modes	2-2	FEATURES_SEL	2-5
		Auto	2-2	FREE_SPACE	2-3
		Man	2-2	HI_HI_LIM	2-15
		Other	2-2	HI_HI_PRI	2-15
		Out of Service	2-2	HI_LIM	2-15
		Monitoring	3-6	HI_PRI	2-15
		Baseline	3-6	IO_OPTS	2-14
		Change	3-6	L_TYPE	2-9, 2-10
		Timestamp	3-6	LCD Transducer Block	A-12
				LIM_NOTIFY	2-5
		N		LO_LIM	2-15
		Network Parameters	2-4	LO_LO_LIM	2-15
		Node address	1-2	LO_LO_PRI	2-15
				LO_PRI	2-15
		O		LOW_CUT	2-14
		Operation	2-1	MAINT_ACTIVE	2-7
		Operation and Maintenance	1-1	MAINT_ALARMS	2-6
		Advanced Diagnostics Transducer		MAINT_ALM	2-7
		Block (ADB)	3-6	MAINT_ENABLED	2-7
		Resource Block	3-2	MAINT_MASK	2-7
		Sensor Transducer Block	3-3	MAINT_PRI	2-7
		OUT_D	2-16	MAX_NOTIFY	2-5
		AI block	2-16	MODE_BLK.TARGET	2-2
				MODE_BLOCK.ACTUAL	2-2
				Network	2-4
				OUT_D	2-16
				OUT_SCALE	2-10

PARAM_INDEX_#	2-17	Configuration Phase	2-19	SPM#_Block Type	2-23
PLINE_AFFECT_PV_STATUS	2-19	Detection Phase	2-19	SPM#_Block_Tag	2-23
PLINE_Auto_Relearn	2-20	History	3-6	SPM#_Parameter Index	2-23
PLINE_Detect_Length	2-21	Learning Phase	2-19	SPM#_Thresholds	2-24
PLINE_Detect_Sensitivity	2-21	Monitoring	3-6	SPM#_User Command	2-24
PLINE_Learn_Sensitivity	2-21	PLINE_Affect_PV_Status	2-19	SPM_Active	2-24
PLINE_Learning_Cycle	2-21	PLINE_SENSITIVITY	2-19	SPM_Bypass_Verification	2-23
PLINE_ON	2-20	Status	3-6	SPM_Monitoring_Cycle	2-23
PLINE_Relearn	2-20	Process Alarms	2-15	Statistical Process Monitoring	2-18
PLINE_Relearn_Threshold	2-20	Propagate Fault Forward	2-15	Statistical Process Monitoring (SPM)	2-22,
PLINE_SENSITIVITY	2-19	Proportional/Integral/Derivative (PID) function block	1-3	Configuration Phase	2-22
PLINE_Single_Detect_Sensitivity	2-21	PV_FTIME	2-9	Learning Phase	2-22
PV_FTIME	2-9, 2-14	AI block	2-14	Monitoring Phase	2-23
RECOMMENDED_ACTION	2-8			Status	3-4, 3-6
REPORTS	2-4	R		AI block	2-15
Resource Block	A-2	Recommended Actions	2-8	High Variation Detected	3-7
Sensor Transducer Block	A-5	PlantWeb Alarms	2-8	Inactive	3-6
SPM#_Block Type	2-23	RECOMMENDED_ACTION	2-8	Learning	3-7
SPM#_Block_Tag	2-23	Reference data	1-1	Low Dynamics Detected	3-7
SPM#_Parameter Index	2-23	Reports	2-4	No Detections	3-6
SPM#_Thresholds	2-24	Resource Block	1-2, 2-4, 3-2, 4-5, A-1	Mean Change Detected	3-7
High Variation	2-24	Block Errors	4-5	Not Licensed	3-7
Low Dynamics	2-24	Block Information	A-1	Verifying	3-7
Mean Limit	2-24	Configuration	2-4	STATUS_OPTIONS	2-15
SPM#_User Command	2-24	Detailed Status	4-5	Supported Units	2-10
SPM_Active	2-24	FEATURES, FEATURES_SEL	2-4	Switches	
SPM_Bypass_Verification	2-23	Operation and Maintenance	3-2	Simulate	3-5
SPM_Monitoring_Cycle	2-23	Parameters	A-2		
STATUS_OPTIONS	2-15	BLOCK_ERR	4-5	T	
UNICODE	2-4	Summary Status	4-5	Timer Recommendations, Host	2-4
UNITS_TYPE_#	2-17	Resource block	A-1	Transmitter functions	3-1
WRITE_LOCK	2-5			Trim	
XD_SCALE	2-9, 2-10	S		Zero	2-9
Permitted Modes	2-2	Security	2-5	Troubleshooting	1-1, 4-2
PID Block	1-3	Self Test	4-7	Advanced Diagnostics Transducer Block (ADB)	4-8
PID block	1-3	Sensor Calibration	3-3	Analog Input (AI) Function Block	4-7
PlantWeb Alarms	2-6, 2-8	Sensor Transducer Block	1-2, 2-9, 3-3, 4-6, A-5	Flowchart	4-2
Advisory	2-7	Block Errors	4-6	LCD Transducer block	4-7
FAILED_ALARMS	2-6	Block Information	A-5	Reference table	4-2
MAINT_ALARMS	2-6	Configuration	2-9	Resource Block	4-5
PLINE_Auto Relearn	2-20	Diagnostics	4-6	Sensor Transducer Block	4-6
PLINE_Detect_Length	2-21	Operation and Maintenance	3-3	Types of Modes	
PLINE_Detect_Sensitivity	2-21	Parameters	A-5	Auto	2-2
PLINE_Learn_Sensitivity	2-21	Troubleshooting	4-6	Man	2-2
PLINE_Learning_Cycle	2-21	Service Support	1-2	Other Types of Modes	2-2
PLINE_ON	2-20	Signal Characterizer Block	1-3	Out of Service	2-2
PLINE_Relearn	2-20	Simulate	3-5		
PLINE_Relearn_Threshold	2-20	Simulation	3-5		
PLINE_SENSITIVITY	2-19	Manual Mode	3-5		
High	2-19, 2-20	Soft W Lock, Hard W Lock	2-5		
Low	2-19, 2-20	SPM#_Baseline_Mean	2-24		
Medium	2-19, 2-20	SPM#_Baseline_Standard_Deviation	2-24		
PLINE_Single_Detect_Sensitivity	2-21				
Plugged Impulse Line Detection	2-18				
Advanced Settings	2-20				
Configuration	2-19				

Model 3051S Series

U

Uncertain	
Limited	2-15
Man Mode	2-15
Unicode	2-4
UNITS_TYPE_#	2-17
Upper Trim Method	3-3

V

Virtual Communication Relationship (VCRs)	2-4
Network Parameters	2-4

X

XD Errors	4-6
XD_SCALE	2-9
XD_SCALE, OUT_SCALE	2-10
L_TYPE	
Direct	2-10

Z

Zero Trim	2-9, 3-4
-----------	----------

Reference Manual

00809-0200-4801, Rev AA
April 2002

Model 3051S Series

Rosemount Model 3051S Series Pressure Transmitters may be protected by one or more of the following U.S. Patent Nos. 4,370,890; 4,466,290; 4,612,812; 4,791,352; 4,798,089; 4,818,994; 4,833,922; 4,866,435; 4,926,340; 4,988,990; and 5,028,746. Mexico Patentado No. 154,961. May depend on model. Other foreign patents issued and pending.

*Rosemount. and the Rosemount logotype are registered trademarks of Rosemount Inc.
PlantWeb is a mark of one of the Emerson Process Management companies.
Foundation fieldbus is a registered trademark of the Fieldbus Foundation.
All other marks are the property of their respective owners.*

Cover photo: Cosmos/305/305h0061.tif

Emerson Process Management

Rosemount Inc.

8200 Market Boulevard
Chanhassen, MN 55317 USA
T (U.S.) 1-800-999-9307
T (International) (952) 906-8888
F (952) 949-7001

www.rosemount.com

**Fisher-Rosemount GmbH & Co. Fisher-Rosemount Singapore Pte Ltd.**

Shipping Address:
Argelsrieder Feld 3
82234 Wessling
Germany
Tel 49 (8153) 9390
Fax 49 (8153) 939172

1 Pandan Crescent
Singapore 128461
Tel (65) 777-8211
Fax (65) 777-0947