

# 4501 Pump Station Monitor

## Installation and Operation Guide



Part #60-4503-016  
Copyright © 2001. All rights reserved. Isco, Inc.  
Revision D, October, 2002





## Foreword

This instruction manual is designed to help you gain a thorough understanding of the operation of the equipment. Isco recommends that you read this manual completely before placing the equipment in service.

Although Isco designs reliability into all equipment, there is always the possibility of a malfunction. This manual may help in diagnosing and repairing the malfunction.

If the problem persists, call or email the Isco Customer Service Department for assistance. Contact information is provided below. Simple difficulties can often be diagnosed over the phone. If it is necessary to return the equipment to the factory for service, please follow the shipping instructions provided by the Customer Service Department, including the use of the **Return Authorization Number** specified. **Be sure to include a note describing the malfunction.** This will aid in the prompt repair and return of the equipment.

Isco welcomes suggestions that would improve the information presented in this manual or enhance the operation of the equipment itself.

### Contact Information

Phone:	(800) 228-4373	(USA, Canada, Mexico)
	(402) 464-0231	(Outside North America)
Repair Service:	(800) 775-2965	(Analytical and Process Monitoring Instruments)
	(800) 228-4373	(Samplers and Flow Meters)
Fax:	(402) 465-3022	
Email address:	info@isco.com	
Website:	www.isco.com	
Return equipment to:	4700 Superior Street, Lincoln, NE 68504-1398	
Other correspondence:	P.O. Box 82531, Lincoln, NE 68501-2531	



# 4501 Pump Station Monitor

---

## *Table of Contents*

### **Section 1 Introduction**

---

1.1 Overview . . . . .	1-1
1.1.1 Instrument Features . . . . .	1-2

### **Section 2 Installation**

---

2.1 Physical Installation . . . . .	2-1
2.1.1 Optional NEMA 4X Enclosure . . . . .	2-1
2.2 Electrical Installation . . . . .	2-2
2.3 Digital Inputs and Outputs Terminal . . . . .	2-2
2.3.1 Current Clamps . . . . .	2-4
2.3.2 Digital Outputs . . . . .	2-6
2.4 Power Supply and Analog Output Terminals . . . . .	2-6
2.5 Analog Inputs (optional) . . . . .	2-7
2.5.1 Labeling Analog Input Data . . . . .	2-7

### **Section 3 Operation**

---

3.1 Using the Instrument . . . . .	3-1
3.2 Instrument Displays . . . . .	3-1
3.3 Instrument Settings . . . . .	3-4
3.4 Pump Station Monitor Operation . . . . .	3-7
3.4.1 Where the Values Come from in the Instrument . . . . .	3-7
3.4.2 The Data logger . . . . .	3-7
3.5 Data Collection . . . . .	3-8
3.5.1 Interrogator Cable . . . . .	3-8
3.5.2 PC Card . . . . .	3-10
3.5.3 Optional Internal Modem . . . . .	3-10

### **Section 4 Maintenance**

---

4.1 Hardware Settings . . . . .	4-1
4.1.1 Display Brightness . . . . .	4-1
4.1.2 Analog Output Adjustments . . . . .	4-1
4.1.3 DIP Switches . . . . .	4-2
4.2 Fuse Replacement . . . . .	4-2
4.3 Troubleshooting . . . . .	4-3
4.4 Advanced Troubleshooting . . . . .	4-3

### **Appendix A Accessories**

---

A.1 Accessories List . . . . .	A-1
--------------------------------	-----

## ***List of Figures***

---

1-1 Model 4501 Pump Station Monitor .....	1-2
1-2 Rear View - Connectors .....	1-3
2-1 4501 in NEMA 4X Enclosure .....	2-1
2-2 Typical Digital Connections .....	2-3
2-3 Connecting a Single Current Clamp .....	2-5
2-4 Power Supply and Analog Output Connections .....	2-6
2-5 Analog Input Examples .....	2-7
3-1 Communication Port Connectors .....	3-8
3-2 Cable Configurations .....	3-9
4-1 Location of Pots and Dip Switches .....	4-1

## ***List of Tables***

---

1-1 4501 Pump Station Monitor Specifications .....	1-4
--	-----

*General Warnings*

Before installing, operating, or maintaining this equipment, it is imperative that all hazards and preventive measures are fully understood. While specific hazards may vary according to location and application, take heed in the following general warnings:

 **WARNING**

**Avoid hazardous practices! If you use this instrument in any way not specified in this manual, the protection provided by the instrument may be impaired.**

 **AVERTISSEMENT**

**Éviter les usages périlleux! Si vous utilisez cet instrument d'une manière autre que celles qui sont spécifiées dans ce manuel, la protection fournie de l'instrument peut être affaiblie; cela augmentera votre risque de blessure.**

*Hazard Severity Levels*

This manual applies *Hazard Severity Levels* to the safety alerts. These three levels are described in the sample alerts below.

 **CAUTION**

Cautions identify a potential hazard, which if not avoided, may result in minor or moderate injury. This category can also warn you of unsafe practices, or conditions that may cause property damage.

 **WARNING**









**Warnings identify a potentially hazardous condition, which if not avoided, could result in death or serious injury.**

 **DANGER**

**DANGER – limited to the most extreme situations to identify an imminent hazard, which if not avoided, will result in death or serious injury.**

*Hazard Symbols*

The equipment and this manual use symbols used to warn of hazards. The symbols are explained below.

<b>Hazard Symbols</b>	
<b>Warnings and Cautions</b>	
	The exclamation point within the triangle is a warning sign alerting you of important instructions in the instrument's technical reference manual.
	The lightning flash and arrowhead within the triangle is a warning sign alerting you of "dangerous voltage" inside the product.
<b>Symboles de sécurité</b>	
	Ce symbole signale l'existence d'instructions importantes relatives au produit dans ce manuel.
	Ce symbole signale la présence d'un danger d'électocution.
<b>Warnungen und Vorsichtshinweise</b>	
	Das Ausrufezeichen in Dreieck ist ein Warnzeichen, das Sie darauf aufmerksam macht, daß wichtige Anleitungen zu diesem Handbuch gehören.
	Der gepfeilte Blitz im Dreieck ist ein Warnzeichen, das Sie vor "gefährlichen Spannungen" im Inneren des Produkts warnt.
<b>Advertencias y Precauciones</b>	
	Esta señal le advierte sobre la importancia de las instrucciones del manual que acompañan a este producto.
	Esta señal alerta sobre la presencia de alto voltaje en el interior del producto.

# 4501 Pump Station Monitor

---

## *Section 1 Introduction*

### 1.1 Overview

The 4501 Pump Station Monitor monitors the operation of the pumps at the pump station as the wet well cycles between full and empty. Combining this information with the known volume between the levels in the wet well, the 4501 uses patented algorithms to calculate the flow into and out of the pump station, and the pumping rate of each pump. Pump activity data is also stored in the 4501's memory.

By using drawdown calculations rather than manufacturers' pump curves, the Isco Pump Station Monitor measures influent flow and pump capacity at most pump stations within 1%.

#### *Displayed Readings*

Pump activity is monitored to derive a cumulative volume, daily volumes, average inflow of the last cycle, calculated outflow, cumulative time and number of occurrences for power failures, high and low level, pump operating time, and pump starts. The flow rates and volumes can be calculated based on preset pump capacity or on a simple volumetric method.

#### *Applications*

The 4501 is extremely flexible. Its multiple inputs and outputs can be configured to perform sewer flow monitoring, and pump performance studies. The 4501 can also become the central component of a proactive pump maintenance program. Other possible uses may include:

- monitor events from external sensors
- activate alarms such as high levels or intrusion
- pace a sampler to collect a flow proportioned sample
- record data on a strip chart or circular chart recorder
- activate a dialer to notify personnel when an alarm condition occurs.

#### *Extended Features*

The 4501 Pump Station Monitor is a sophisticated data logger. It stores up to 29,000 events in battery-backed memory. Examples of events are pump start, pump stop, rain gauge pulse, intrusion, power failure, etc. If analog events are recorded, fewer events will be recorded. When the memory is full, the data is overwritten as first in, first out—commonly called “roll-over mode.”

Optional Isco Pumplink™ software can be used to retrieve and analyze the stored data. Retrieved data may be used for:

- detailed billing
- inflow and infiltration (I&I) studies
- analyzing events logged by external sensors
- detailed analysis of pump station performance

### Data Retrieval

Pumplink software also allows you to assign labels to the data recorded on the user inputs, program the 4501 to pace a sampler and can be used to update the 4501 firmware.

Basic configurations of the 4501 allow data retrieval through a direct serial RS-232 connection. For convenience, a serial port is available on the front panel; permanent installations may opt to use the rear panel DB-9 connection instead. Other configurations add a PCMCIA card slot, a telephone modem, or both, to the standard RS-232 data transfer methods.

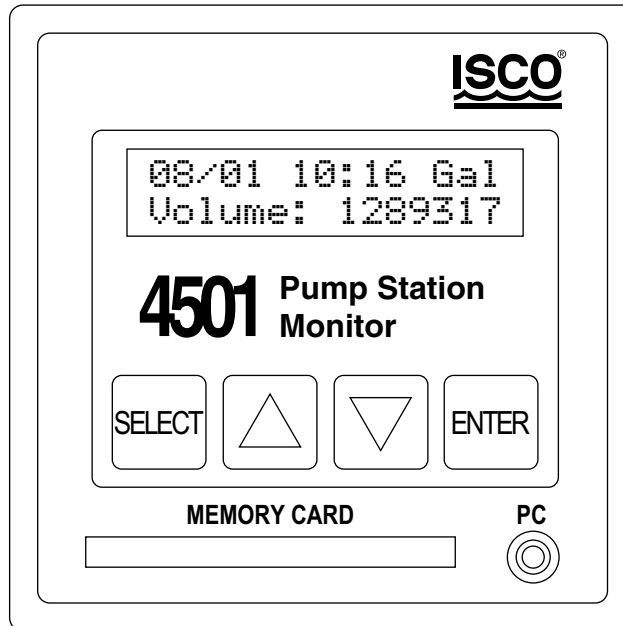
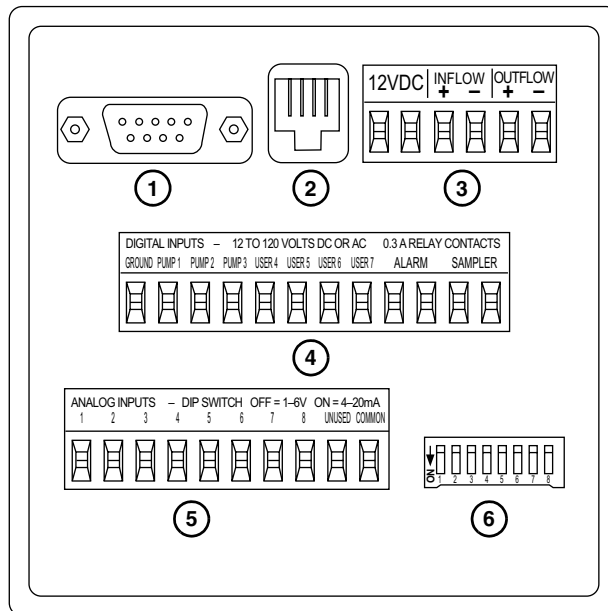

Figure 1-1 Model 4501 Pump Station Monitor

#### 1.1.1 Instrument Features

- Standard size DIN enclosure for easy installation
- Alphanumeric display for easy-to-read and easy-to-understand data
- Clear plastic splash proof cover to protect the display, keyboard, RS-232 connector and PC Card slot
- Seven digital inputs: three pumps and four user inputs (rain gauge, high level, intrusion, etc.)
- Two digital outputs (open collector) for alarms and sampler
- Two analog outputs proportional to outflow and inflow for telemetry system, sampler or chart recorder
- Front RS-232 serial port for fast and easy access
- Rear RS-232 serial port for permanent installation
- Optional eight analog inputs: 4-20 mA, 0-5 VDC DIP switch-selectable (pressure, temperature, level, etc.)
- Optional built-in 2400 baud auto-answer modem
- Optional PCMCIA Card support



- 1 RS-232 Serial Port
- 2 Optional Internal Modem Connection, USOC RJ11C
- 3 12 VDC Power and 4-20 mA Analog Outputs
- 4 Pump and User Digital Inputs
- 5 Analog Inputs (optional)
- 6 DIP Switches to configure Analog Inputs (optional)

Figure 1-2 Rear View - Connectors

Table 1-1 4501 Pump Station Monitor Specifications		
Size (H × W × D)	3.75 × 3.75 × 7.1 in.	9.5 × 9.5 × 18.1 cm
Weight	1.4 lb.	0.63 kg
Material	Polyphenylene Oxide	
Power	12 VDC, 250 mA	
Program Memory	Battery-backed RAM; can be updated via interrogator port without opening the enclosure.	
Display	Backlit liquid crystal, 2 lines × 16 characters	
Keypad	Membrane, 4 position	
Pump inputs	3, rated 12 to 120V AC or DC. Inputs may be anything that changes state when the pumps are activated.	
Digital Inputs	4, rated 12 to 120V AC or DC	
Data Storage Memory Capacity	29,000 events maximum	
Storage Mode	Rollover	
Data Retrieval	Direct RS-232 connection, optional PCMCIA card, optional internal modem	
Data Analysis	Isco Pumplink for Windows Software	
Battery Back-up Life	10-year internal battery life expectancy, protecting program and data storage memory.	
Typical Accuracy* 4501 Monitor	±1% totalized flow, ±8% cycle to cycle	
Pumplink Software	±1% totalized flow, ±5% cycle to cycle	
Relay Outputs	2 normally open, rated 1 A at 30 V DC or 0.3 A at 125 VAC, one proportional to outflow, one activated based on minimum and maximum analog inputs and abnormal pump capacity.	
Analog Outputs	2 proportional to inflow and outflow rates, 4 to 20 mA into a maximum of 400 ohms.	
Operating Temperature	0° to 140°F	-18° to 60°C
Storage Temperature	-40° to 140°F	-40° to 60°C
Available Options	<ul style="list-style-type: none"> <li>• Universal AC input (120 to 240 VAC, 50 to 60 Hz) Power Supply</li> <li>• Analog Inputs: 8 single-ended mixed with 4 differential, individually selectable 4 to 20 mA or 0 to 5 V</li> <li>• PCMCIA Card (PC Card) removable memory</li> <li>• Internal 2400 baud auto-answer telephone modem</li> <li>• Fixed-site/Portable NEMA 4X enclosure with power supply and 9-pin stereo interrogator cable</li> </ul>	
*Does not include errors in wet well measurements.		

# 4501 Pump Station Monitor

## Section 2 Installation

### 2.1 Physical Installation

A  $\frac{1}{4}$  DIN square hole, size  $3\frac{5}{8}'' \times 3\frac{5}{8}''$  (92mm  $\times$  92 mm), should be cut in the control panel front door. Six inches (153 mm) of free space behind the panel must be available. If the only space available to you is six inches or 153 mm, it would be prudent to put some electrical insulation behind the connectors. The screw-type brackets slide into place from front to rear after the unit is inserted in place.

#### **Note**

Never install the unit closer than one foot from the pump's starters. Microprocessor-based instruments can be affected by strong magnetic fields.

#### 2.1.1 Optional NEMA 4X Enclosure

If mounting the 4501 in a control panel is not practical for your application, the 4501 can be ordered in a NEMA 4X enclosure. This lockable enclosure includes internal wiring that provides overload protection for the 4501. It is available in portable and fixed-installation configurations. Contact the factory for ordering information.

#### **WARNING**

**HAZARD of ELECTROCUTION. AC line voltage is present on terminals inside this enclosure. Disconnect power before opening case or front panel, or before servicing. To avoid electrical shock, installation and service should be done by qualified personnel. Incorrect handling of the 115/230 VAC power supply can kill you. For this reason, service of components subject to high voltage should be carried out only when the power has been disconnected.**



Figure 2-1 4501 in NEMA 4X Enclosure

## 2.2 Electrical Installation

 **WARNING**

**Always remove power from the control panel before attempting any modification.**

 **WARNING**

**Electrical connections should be made by qualified electrician.**

Most control panels use the following color code for the wires:

- Green – Ground.
- White – Neutral.
- Black – 120V AC (also called Hot) is always ON except when the Master Switch is OFF.
- Red – Controlled live. These lines can become live at any stage of the operation. Always treat them as if they were live.

The terminal blocks on the back of the 4501 are removable. These can be removed from the instrument while attaching the various wires and replaced after the wires have been inserted into the block and tightened.

The removable terminal blocks allow you to quickly remove and replace the 4501. If the instrument sees temporary use in several locations, spare terminal blocks can be ordered from the factory to facilitate quick change-outs at all locations. See Appendix A for a listing of accessories.

When making the connections to the 4501, you may find that it's easiest to start with the lowest terminal blocks and work towards the top. Connections to each of the terminal blocks are discussed in sections 2.3 through 2.5.

## 2.3 Digital Inputs and Outputs Terminal

The digital inputs will work with AC and DC current. It is possible to use AC and DC at the same time if the ground is used as the common. The terminals are, from left to right, the ground (or neutral or negative), pump 1, pump 2, pump 3, user 4 to user 7 (which can be used for level alarms, maintenance time recording, rain gauge, intrusion, etc.), pump capacity and analog input alarms contacts and sampler contacts. The user inputs can be labeled using Pumplink software; otherwise generic labels are used, such as "INPUT#4."

Using the ground as the common instead of the neutral is practical because AC and DC of different voltages can be connected at the same time. This can be useful when a rain gauge is connected at the same time as the pumps (refer to Figure 2-2). The ground is also one of the easiest connections to find.

**Note**

Using the ground as common for mixed voltages and polarities may not meet code requirements in some jurisdictions. Consult code authority before making such an installation.

The instrument is made to record change-of-state of the digital inputs. The voltage should be between 12 and 120 volts. Anything that changes condition at the same time as the pump, such as starters, lights, or timers, can be connected to the corresponding pump input.

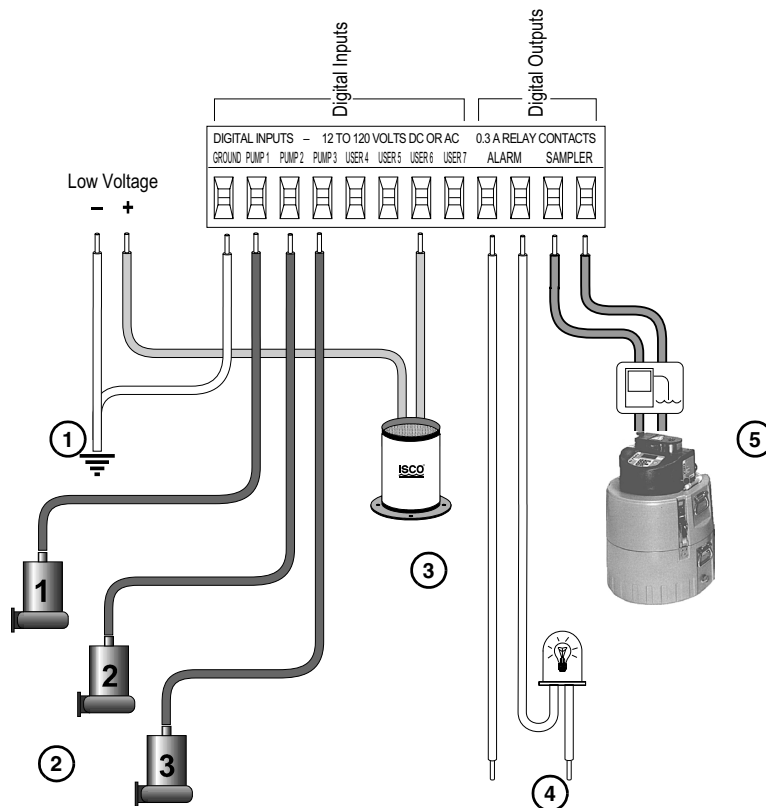

- 1 Connection may be Ground, and/or Neutral and/or Negative, depending on the application and electrical codes.
- 2 Pump connections are to any source that changes state at the same time as the pumps. The source can be 12 to 120 Volts AC or DC tapped from points such as starters, timers, relays, or pilot lights.
- 3 A tipping-bucket rain gauge is depicted as a user input. User inputs can be a variety of true/false conditions, such as High and Low Level alarms, Intrusion interlocks, or maintenance alarms.
- 4 The alarm system requires a power source to drive your indicator of choice. For example, the power source may be 120 VAC from the control panel.
- 5 A sampler or similar device can be paced by the 4501. Here, the sampler output is connected to the Isco sampler's flow meter connector, pins A (12 VDC) and C (Flow Pulses In).

Figure 2-2 Typical Digital Connections

The electronics will detect change-of-state at lower voltage than 12 volts, so it is important to check that you do not see a pump ON status (X) on the display when that pump is OFF. Sometimes, there is some residual electricity, even when pumps are off. It is not normal, but it is common. The residual voltage is usually too low to create a short term major problem with the electrical system, but it could badly influence the events recorded by the 4501. Residual voltage is usually lower than 10 volts. When this condition occurs, test the voltage between the questionable input and the common (usually the ground). If you measure higher than one volt, check between the input and the neutral. If you still show voltage and you are sure that you see a significant change of voltage on a volt meter when the pumps are turned on, ask an electrician to correct the problem. It is an abnormal condition that should be corrected. If a residual voltage is always present, insert relays into the electrical system and use their contacts to obtain the same type of input.

### 2.3.1 Current Clamps

The optional current clamps are the fastest and safest way to connect the 4501 to a pump station control panel. The adjustable set point and status LED make installation very easy. Being directly connected (without current sensor) gives faster electrical response to the 4501 (in case of chattering relays).

 **WARNING**

**Status indicators of this device should not be relied on to determine whether or not the monitored conductor is energized. Doing so may result in injury or death from electrical shock.**

The optional current clamps are available from Isco under the following part numbers:

- 60-5314-025, a single current clamp to monitor one pump
- 60-5314-097, a pair of pre-wired current clamps for monitoring two pumps
- 60-5314-174, three pre-wired current clamps for monitoring three pumps

#### *Current Clamp Installation*

 **CAUTION**

Before attaching the current clamp, disconnect and lock out power from the circuits that will be monitored.

1. Attach the sensor around a single conductor to be monitored. Low (<1.5 amps) and high (>200 amps) current applications may require special installation.

If the current is less than 1.5 amps, wrap conductor through the center hole and around the sensor body to produce multiple turns and increase current flow.

$$\text{Measured Current} = \text{Actual Current} \times \text{Number of turns}$$

If the current exceeds 200 amps, select another conductor that powers a device at the same time the pump is powered.

**Note**

The current clamp should be placed around a single conductor.

2. Connect one side of the sensor's terminal to the 4501's 12 VDC power and the other terminal to the corresponding pump input on digital input terminal. See Figure 2-3. The connections on the current clamp are not polarity-sensitive.
3. Start the pump. If the monitored conductor exceeds 1.5 amps, the 4501 should indicate a "Pump On" status.

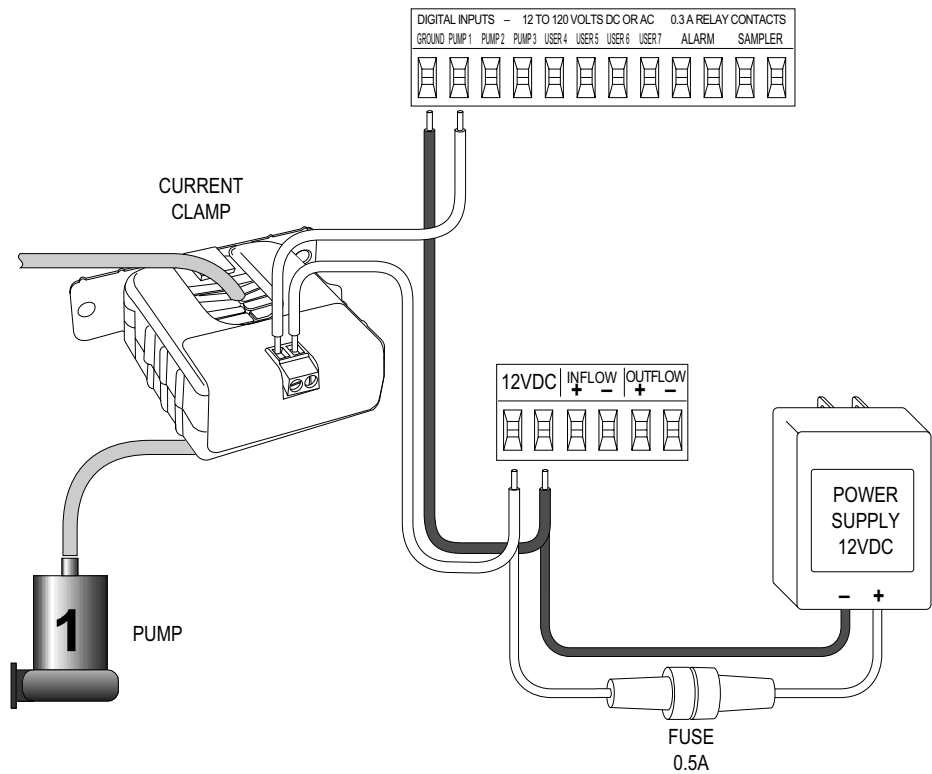

Figure 2-3 Connecting a Single Current Clamp

### 2.3.2 Digital Outputs

The two digital outputs use dry form “C” (SPDT) contacts and are rated 300 mA, 120 VAC. The pump capacity alarms relay contacts close when a pump capacity varies by more than 30% for a minimum of five cycles. The variation of 30% is a default value suitable for most applications, but can be changed to any percentage in 1% increments (see Section 3). The sampler contacts are programmed Pumplink for Windows software to generate a one-second pulse each time the preset volume is pumped out of the station.

## 2.4 Power Supply and Analog Output Terminals

The power supply negative and positive must not be reversed. If you use the analog outputs, the power supply positive must be on the first (leftmost) terminal.

### CAUTION

Always connect the power supply adapter leads to the 4501 terminal before plugging the adapter into the 120 VAC outlet. This reduces the build-up of surge by the power supply coil.

The terminals are, from left to right, 12 VDC, 12 VDC, Inflow 4-20 mA+ and 4-20 mA–, Outflow 4-20 mA+ and 4-20 mA– (refer to Figure 2-4).

To connect an analog instrument on the analog outputs of the 4501, connect the + and – from the instrument to the + and – of the 4501. If the analog instrument uses 0-5 VDC, connect a 250 ohm resistor between the + and –.

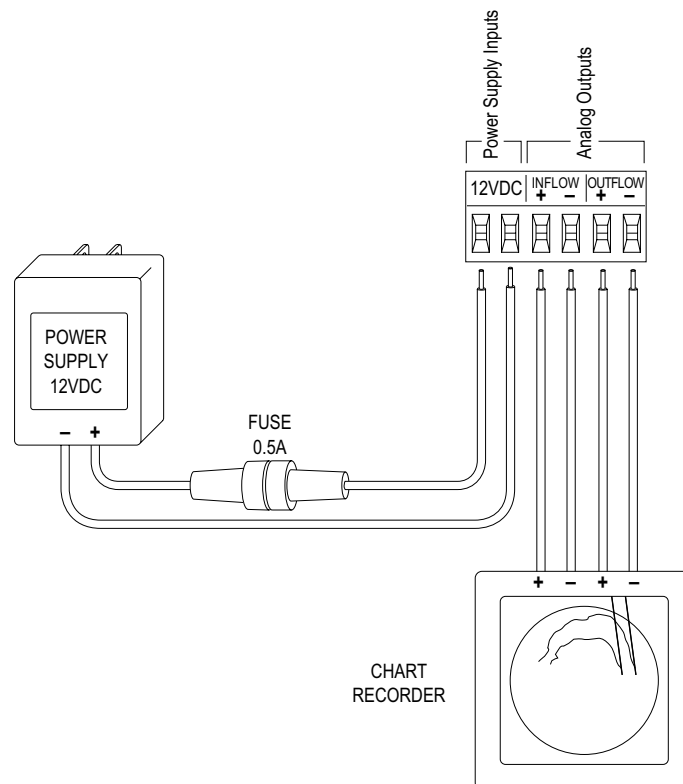

Figure 2-4 Power Supply and Analog Output Connections

## 2.5 Analog Inputs (optional)

The analog inputs option provides eight analog inputs. They can be a mix of 4-20 mA and 0-5 Volts. DIP switches are used to select between Volts and mA. The ON position will be clearly labeled on the DIP switch.

- DIP switch ON: 4-20 mA
- DIP switch OFF: 0-5 Volts

Only one terminal is provided for a common, which means all inputs must have the same common. Figure 2-5 shows an example of some possible analog input connections.

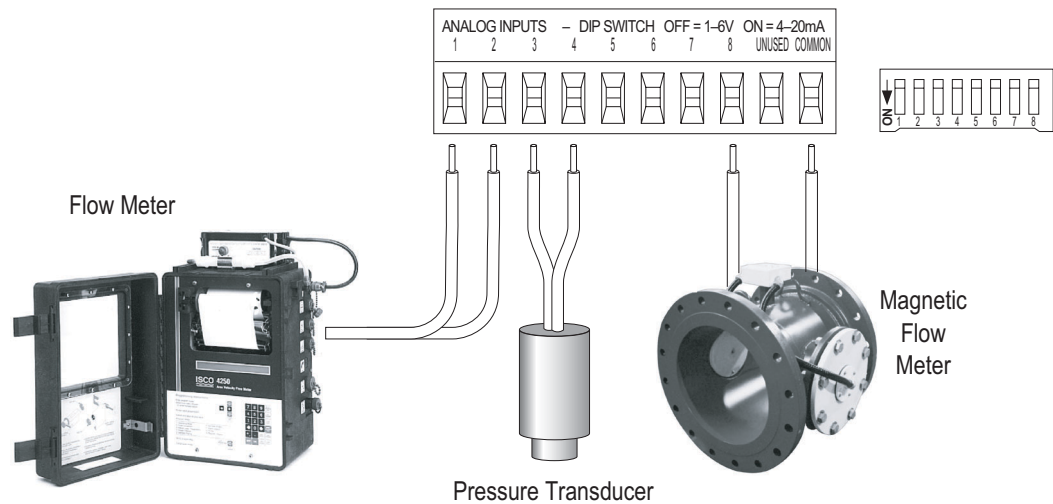

Figure 2-5 Analog Input Examples

### Differential Analog Inputs

When using the four differential inputs the DIP switches must be OFF. If connecting differential inputs, the input terminal pairs are 1-2, 3-4, 5-6, 7-8, and note that the COMMON input is not used. If the pair of differential inputs is a 4-20 mA signal, install a 250 ohm resistor between the two terminals where the 4-20 mA current loop wires are connected.

### 2.5.1 Labeling Analog Input Data

By default, analog input data is “undefined.” That is, the 4501 stores and displays the analog input as a percentage of the selected range, without a descriptive label and measurement units. For example, if the input voltage was 3 volts, the displayed and stored value would be “60%” of the 0 to 5 volt scale.

Optional Pumplink software can be used to define the input scale, the displayed readings scale, descriptive labels, and measurement units. Refer to Pumplink’s help file for more information.



# 4501 Pump Station Monitor

## Section 3 Operation

### 3.1 Using the Instrument

The basic parameters needed by the 4501 in order to calculate volume and inflow are the pump capacities for each combination of pumps and the volume between the lead and stop level (if single pump capacities are calculated on-site). If you want the 4501 to log the data properly, the correct date and time must be programmed. *It is highly recommended that you do an Event Reset or Total Reset after changing the date.* If you leave an event recorded with the wrong date (like a power ON), you will get blank reports for the time between the wrong date and the right date. If you already preprogrammed settings in the instrument, use the Event Reset.

The unit has two modes:

- **Regular mode** is used to display the results on the LCD screen
- **Instrument Settings mode** is used to give the necessary parameters for the unit to process the data properly.

```
INITIALIZATION
Version 1.22
```

After powering the instrument, this display appears momentarily. This is the only way to read the instrument internal software version.

```
For SETUP Press
SELECT 3 seconds
```

This display is to remind you that you can access the 4501 Instrument Settings screens from any normal mode screen by pressing SELECT for three seconds. Note that pressing SELECT a second time will exit the settings mode and return the 4501 to the regular mode.

### 3.2 Instrument Displays

```
ALARM - ALARM -
Scrolling messag
```

To scroll to the following display, press DOWN.

To scroll back to the previous display, press UP.

This is a scrolling message displayed only when one or more alarms occur related to the analog inputs and/or to major pump capacity variations. A message having both alarms would be: "Analog inputs in alarm: 3, 4 - Pumps in alarms: 2 - Press any key to reset every alarm." This message means:

- A lower than minimum and/or higher than maximum values were read on the analog inputs number 3 and 4, – and –
- Pump number 2 capacity changed by more than 30% for more than five cycles in a row.

Pressing a key resets the alarm condition and clears the screen.

```
date: 02/18/2002
time: 11:51:27
```

This display shows the actual date and time. If the time is wrong, the events will be recorded with the wrong time. To correct this, enter the instrument settings mode.

**Note**

It is recommended that you do an Event Reset or Total Reset after changing the date.

```
02/18 11:52 Gal  
Volume: 215487
```

This display shows volume units and cumulative volume since the reset of the instrument.

The instrument uses a very simple algorithm to calculate volumes and flows. Pumplink software uses the full power of a computer to calculate volumes and flows. Therefore, you will not see the same results on both the software and the instrument.

**Note**

If the instrument is used for billing purposes, we strongly suggest using Pumplink software.

```
Inflow Outflow  
25.75 74.36
```

This display shows the average inflow of the last cycle and the pump capacity of the pumps in operation. The inflow is calculated using the preset or calculated pump capacities.

You must enter a pump capacity for every combination of pumps used in the station. If you want the instrument to calculate the flow in and out using a volumetric method, then you need to enter the volume between lead and stop level in the appropriate section of the settings for the instrument.

The volumetric method must be used for the instrument to generate pump capacity alarms. If you don't want to use the volumetric method, but want to use preset pump capacity, then don't forget to enter capacities for each pump. (More information on this is in section 3.3.)

```
Capacity Pump 1  
128.12 G/m
```

This display shows the capacity of pumps 1, 2 and 3. If you have selected *Use Volume to Find Flows* in the settings mode, then the pump capacity is based on the last drawdown calculation. If you have selected *Always Use Pump Capacity* in the Settings section, then the pump capacity is the one entered in the *Set Pump Capacity* screen. Press DOWN to scroll through each pump. Only the single pumps are shown because only their capacity can be calculated, if the volumetric method is used.

```
Pump 1  
Hrs: 00051:25:12
```

This display shows the operation time of the pumps. Press DOWN to scroll through each pump and combination of pumps.

The 4501 will record pump operation even if the pump is operating only for  $\frac{1}{10}$ <sup>th</sup> of a second, something that control panel elapse timers can't do. This is why it is possible to have a difference between them. This is especially true for pumps having chattering relays. This intermittent abnormal condition is seen in most pump stations and is usually how major problems begin. This condition will deteriorate if nothing is done about the relay causing the problem. This condition should not affect the flow calculation, unless major problems occur. Pumplink software shows them as *filtered* events.

A chattering relay can deteriorate to the point where it won't start the pump any longer, which means the same pump is always operating. A chattering relay can also deteriorate to the point where its contacts melt, which means the pump is operating until it burns itself out.

```
Pump 1  
Starts: 00000894
```

This display shows the number of starts of the pumps and the number of times each combination of pumps was used. Press DOWN to scroll through each pump and combination of pumps.

```
Power F.: 0012  
Hrs: 00000:14:12
```

This display shows the cumulative number of power failures and their cumulative time.

```
AI1:  
28.20 -----
```

This display shows the optional analog inputs 1 (AI1) to 8 (AI8). If the 4501 has not been configured with Isco's Pumplink software, the label and units of measure are blank. its description, By default, the inputs will be displayed as a percentage between 0 and 5 volts, or between 4 and 20 mA, depending on the DIP switch setting for that analog channel. If the 4501 has been configured with Pumplink, the label and units of measure can be displayed with the value, as shown in the next display.

```
AI1: PRESSURE  
35.25 PSI
```

This analog input display includes the label and units of measure that were set up using Pumplink. In addition to labeling the inputs, the linear input scale and the displayed range of values can be set. For example, if a pressure sensor reads 50 PSI at a full-scale voltage of 2.0 volts, the input range (0 to 100%) can be modified to 0 to 2 volts, and the displayed range can be set to read from 0 to 50 PSI.

**Note**

The precision used to record the input is 8 bits. Eight bits means a precision of 1/256 or 99.6%. Most applications will not require higher accuracy because the sensors connected to the input or their installation do not permit accuracy higher than 99.6%.

Refer to Pumplink's help file for more information on Instrument Settings and the "*Item>Program Instrument*" function.

```
Daily Vol. 02/17  
012547.54 Gal
```

This display shows daily volume of the last eight days (or since last reset) with the date and volume units. Press DOWN to scroll through the past days and to get to the next display.

```
Records: 29002  
from 01/01 00:00
```

This display shows the number of records in memory and the date and time of the first record. The first in, first out condition makes the date and time change when the memory is full.

```
Inputs 12345678  
0X000000
```

This display shows the status of the seven digital inputs which are: Pump 1, Pump 2, Pump 3, User 4 to 7. When the input is not energized, a "0" is displayed. When the input is energized, an "X" is displayed. This display is used to test the inputs. By default, the instrument expects normally open connections, which means not energized when not in operation.

If, for any reason, the connection that you have works the opposite way, Pumplink software may be used to change them to normally closed. Refer to Pumplink's help file for more information.

### 3.3 Instrument Settings

To enter the instrument settings mode, press SELECT until a new display appears. To scroll in the settings displays, press ENTER. If a value must be entered, press DOWN or UP to select it. Press ENTER to accept the value set and get to the next display.

If you incorrectly change a setting, you can return to the screen by pressing ENTER until you return to the screen. Note that depending which setting must be changed, it may be quicker to exit and re-enter the settings mode and press ENTER until you return to the display.

```
Press both arrow  
for events RESET
```

This display lets you reset all the events in memory, but not the settings. It is useful after you have checked the instrument to make sure that all is operating properly with the pumps, then you do the *Events Reset*. Press UP and DOWN simultaneously until it says "All Records Are Now Erased."

```
Press both arrow  
for TOTAL RESET
```

This display lets you do a *Total Reset* of all events and settings, except the date and time. Press UP and DOWN simultaneously until it says "Complete Reset Done."

```
CHANGE Digital  
output 1: off
```

This display lets you manually change the state of the two digital outputs for testing. Press UP or DOWN to change the status of the output. This is useful to test equipment connected to the instrument.

```
CHANGE Analog  
output In : 010%
```

This display lets you manually change the value of the two analog inputs for testing. Press UP to increase by 10% the value of the output and press DOWN to decrease the value by 10%. This is useful to test equipment connected to the instrument.

```
CHANGE Analog  
output Out: 020%
```

This display lets you manually change the value of the two analog outputs for testing. Press UP to increase by 10% the value of the output and press DOWN to decrease the value by 10%. This is useful to test equipment connected to the instrument.

```
CHANGE date  
format: mm/dd/yy
```

This display lets you set the hour format. Press UP or DOWN to select between mm/dd/yy and dd/mm/yy.

```
CHANGE month  
date: 02/18/02
```

This display lets you set the month. Press UP or DOWN to adjust the month.

```
CHANGE day  
date: 10/16/01
```

This display lets you set the day of the month. Press UP or DOWN to adjust the day.

```
CHANGE year  
date: 10/17/01
```

This display lets you set the year. Press UP or DOWN to adjust the year.

```
CHANGE hour 24h  
time: 12:13:45
```

This display lets you set the hour using the 24 hour format. Press UP or DOWN to adjust the hour.

```
CHANGE minutes  
time: 12:16:12
```

This display lets you set the actual minutes. Press UP or DOWN to adjust the minutes.

```
CHANGE seconds  
time: 12:16:00
```

This display lets you set the actual seconds. Press UP or DOWN to adjust the seconds.

```
arrow to change  
TIMER INSTRUMENT
```

This display lets you specify if you want to start the timers of the pumps at zero or if you prefer to enter the values read off the control panel elapsed timers. Press UP or DOWN to select between *Timer Instrument* (zero) and *Timer Ctrl Panel* (elapsed timers).

```
Change timer for  
pump 1: 3425.7
```

This display appears if *Timer Ctrl Panel* is selected. Press UP to increase the pump timer value or DOWN to decrease it by  $1/10^{\text{th}}$ . Pressing and holding the arrow key will adjust the value at a faster rate.

```
Pump alarm is  
NOT ACTIVE
```

This display gives you the choice of closing the digital alarm output based on abnormal pump capacity. The capacity of the pump must have changed by more than a predetermined percentage (next display) for at least five times in a row (not necessarily five cycles in a row). Press UP or DOWN to select between *Not Active* (alarm not activated based on abnormal pump capacity) and *Active*. If *Active*, the following screens will be displayed.

```
Max pump var.  
for alarm: 030%
```

This display appears if *Pump Alarm Is Active*. Press UP or DOWN to change the percentage in 1% steps. The percentage represents the difference between the average pump capacity (calculated over many cycles and updated every cycle) and the last drawdown calculation.

```
Pump alarm is  
LATCHED
```

This display shows if *Pump Alarm Is Active*. Press UP or DOWN to select between *Latched* and *Toggle*. Latched means the alarms will stay on until you press a key (locking). Toggle means the alarm will go off automatically if the pump goes back to its normal capacity (non-locking).

```
Analog alarm is  
ACTIVE
```

This display gives you the choice of closing the digital alarm output based on minimum and maximum values reached and set through Pumplink software. Press UP or DOWN to select between *Not Active* (alarm not activated based on analog input readings) and *Active*. If *Active*, the following screens will be displayed.

Note that Pumplink can configure the 4501 to activate the alarm output for multiple conditions. Conditions may include the *Max Pump Var.*, and any user-defined parameters that are exceeded by an analog input. The alarm is activated when any *one* of the conditions are "true."

```
ANALOG ALARM IS  
LATCHED
```

This display appears if *Analog Alarm Is Active*. Press UP or DOWN to select between *Latched* and *Toggle*. Latched means the alarms will stay on until you press a key. Toggle means the alarm will go off automatically if the analog inputs read higher than the minimum and lower than the maximum set through Pumplink software.

```
Alarms are  
NOISY
```

This display is selected by pressing UP or DOWN. Noisy means the instrument will beep to get your attention when an alarm condition occurs.

```
Measuring units  
Flow: MG/D
```

This display lets you set the flow units. Press UP or DOWN to select between G/m, MG/D, and Li/s (Gallons per Minute, Million Gallons per Day, and Liters per Second).

```
Measuring units  
Volume: Gal
```

This display lets you set the volume units. Press UP or DOWN to select between Gal, MG, Li, and M3 (Gallons, Millions of Gallons, Liters, and Cubic Meters).

**Note**

Additional flow and volume units can be programmed using Pumplink software.

```
Always use  
pump capacity
```

This display means the inflow is calculated based on preset pump capacity. In other words, what goes out must have come in. If you select this option, you must enter the pump capacity for every combination of pumps (including single pumps). When you switch between this selection and *Use Volume to Find Flows*, all the cumulative volumes are reset. Press UP or DOWN to get to the other choice (shown next).

```
Use volume to  
find flows
```

This display means that you calculate inflow and outflow based on volumetric drawdown calculation. If you select this option, you must enter the volume between the start (lead) and stop level when the next display asks for it. The algorithm is good for single pump operation only.

**Note**

When using *Use Volume to Find Flows*, you must enter the capacity for each pump combination.

The algorithm assumes that the pumps can alternate. In their single operation, they start at the same level, and stop at the same level. If your station operates differently, select *Always Use Pump Capacity*. When you switch between this selection and *Always Use Pump Capacity*, all the cumulative volumes are reset. Press UP or DOWN to get to the other choice (shown previously).

```
Volume Bet. lead  
& off:3425 Gal
```

If *Use Volume to Find Flows* is selected, you must enter a volume between the start level (lead) and stop level. Press UP to increase the volume or DOWN to decrease it.

```
Set Capacity  
Pump 1: 122 G/m
```

This display lets you set the outflow for each pump and combination of pumps.

```
CHANGE: communic  
with direct link
```

This display lets you set the type of communication between the instrument and your computer. Press UP or DOWN to select between *With Direct Link* (RS-232), *With Ext. Modem* (external modem) and *Through Modem* (internal modem). The external modem option only applies to European applications.

**Note**

You must shut the power off for at least five seconds after changing the communication configuration for the hardware to be reset to the new configuration.

### 3.4 Pump Station Monitor Operation

 **Note**

This section discusses the Pump Station Monitor operation and its calculation of values. It does not discuss the higher accuracy calculations that Pumplink software can offer. If greater accuracy is necessary for your application, you must use the Pumplink software. Refer to Pumplink's help file for more information.

#### 3.4.1 Where the Values Come from in the Instrument

When an event occurs, the time of occurrence, the description and the value of the event are recorded.

- The cumulative number of occurrences is updated.
- If a preset low or a high limit is reached, the alarm output is closed.
- The analog output, proportional to outflow, is calculated and activated.
- At the end of a cycle, when all pumps stop, an average inflow is calculated for the cycle, based on the liquid that went through the station, calculated from the pump capacity.
- The analog output, proportional to inflow, is calculated and activated.
- Every second the time of operation is updated.
- Every second the total and sampler cumulative volumes are updated based on the pump's capacity.
- Every second the display is updated.
- Each time the sampler's volume is reached, a one-second pulse is generated on the digital output SAMPLER.

#### 3.4.2 The Data logger

The data logging capacity of the 4501 is a feature that you might never need or use because many customers find the displayed information of the instrument enough for their needs. However, data logging is there and active should you need it. It could be extremely valuable, especially at start-up time, to check the operation of a newly updated or newly built pump station.

The 4501, in its battery-backed memory, records events such as pump start or stop, high level, rain gauge pulse, power failure, analog inputs, etc. When the memory is full, the newest information is written over the oldest. It is called *first in - first out*, or *roll-over* mode. The 4501 starts to record when it is powered. This means you could connect the 4501 and leave it there without touching the keyboard, and it would record the events anyway.

What do 29,000 events signify? If you had a pump station with an average pumping cycle of 20 minutes, 10 minutes during the day and 30 minutes at night, you would then be able to record about six months' data.

You might never need this data, but if you suspect that something unusual is going on at the pump station, the 4501 will have the last few months in its memory. Of course, if you use Pumplink software, this data is required. The instructions on how to retrieve the information from the 4501 is in the Pumplink help file.

### 3.5 Data Collection

#### *Pumplink for Windows*

When using the Data Logger feature of the Pump Station Monitor, the stored data must be retrieved from the unit. This data can then be processed and viewed with Pumplink. Data can be collected with an RS-232 connection via an Interrogator Cable, or the optional modem and PC Card.

To read the station file from a PC Card, or to communicate directly with the 4501, Pumplink must first be configured properly. The settings are located on the Station Communication tab of Pumplink's Instrument Setup window.

- RS-232 communication should use the *Link using COM X* option, where *X* is the COM port of the serial port in use.
- To read a file transferred from a PC Card, use the *Read Raw Data from file* option.
- To communicate via telephone modem, select the *Link using Modem* option.

The modem option will also require a telephone number to be entered.

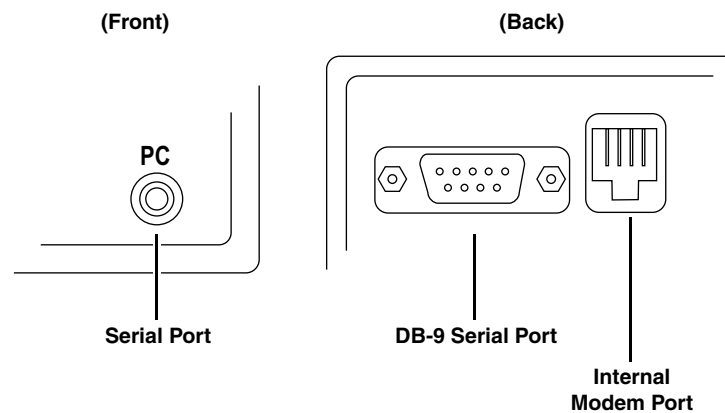

Figure 3-1 Communication Port Connectors

#### 3.5.1 Interrogator Cable

The interrogator cable can be used to download the data from the 4501 into Pumplink.

**Note**

You cannot use the front and the rear connector simultaneously. They are connected to the same internal serial port. Doing so could damage the equipment.

**✓ Note**

The interrogator cable and the modem are the only means of setting the analog inputs, the sampler output, and some alarm parameters.

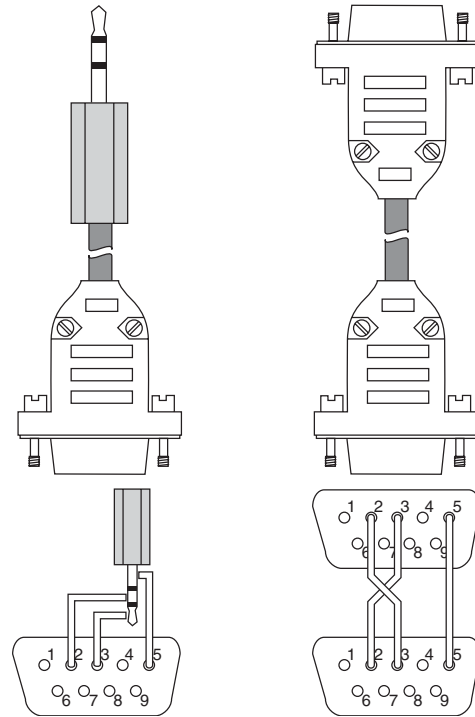

- |   |                           |          |
|---|---------------------------|----------|
| 1 | CD (Carrier Detect)       | NOT USED |
| 2 | <b>RX (Receive data)</b>  |          |
| 3 | <b>TX (Transmit data)</b> |          |
| 4 | DTR (Data Terminal Ready) | NOT USED |
| 5 | <b>Ground</b>             |          |
| 6 | DSR (Data Signal Ready)   | NOT USED |
| 7 | RTS (Request To Send)     | NOT USED |
| 8 | CTS (Clear To Send)       | NOT USED |
| 9 | RI (Ring Indicator)       | NOT USED |

Figure 3-2 Cable Configurations

### 3.5.2 PC Card

The PC Card, also called PCMCIA card, is a convenient way to transfer the data from the 4501 to an office computer equipped with a PCMCIA Card Reader. The PC Card socket of the 4501 is made to use a standard Type I SRAM PC Card, with 1 or 2 MB storage capacity.

When using a PC Card, insert it in the PC Card socket of the 4501, wait a few seconds, and remove it when the display says it is safe to do so. This process can be repeated for additional pump stations with the same PC Card. When you get back to the office start Pumplink software, insert the PC Card in to the computer's PC Card reader, then transfer each data file from the PC Card into their station file.

The number of pump station files that may be stored on a PC Card is determined by the number of events stored in each 4501. If all 4501s have stored the maximum number of events (that is, all are in roll-over mode), a 1 MB card can hold data from 16 pump stations; a 2 MB card can hold data from 32 pump stations. More pump stations may be stored on a PC Card if the 4501 memory is not in roll-over mode. Regularly resetting the stored events after transferring the station file will keep the number of stored events to a minimum if this is a necessity.

### 3.5.3 Optional Internal Modem

The internal modem lets the 4501 transmit and receive data over phone lines. It is auto-answer and operates at 2400 baud. Pumplink has all the modem communication functions built-in and instructions on how to use it. The only thing required is the standard telephone cable usually found between the telephone and the wall. The communication cable and the modem are the only means of setting the analog inputs, the sampler output and some alarm parameters.

If the 4501 has a firmware version less than 1.22, it must be updated to at least 1.22 for successful communication with an internal modem.

# 4501 Pump Station Monitor

## Section 4 Maintenance

### 4.1 Hardware Settings

The analog outputs and the display brightness are factory-set. However, if there is a later need to readjust these settings, they can be calibrated with the potentiometers on the left side of the 4501. Refer to Figure 4-1. Calibration procedures are described in the following sections.

 **WARNING**

**Adjustments should be performed by a trained technician. The following procedures are performed while power is applied to the 4501. Although lethal voltages do not exist on the input power and analog output terminals, dangerous voltages may be present on the analog or digital channels and nearby terminals on the pump station control panel.**

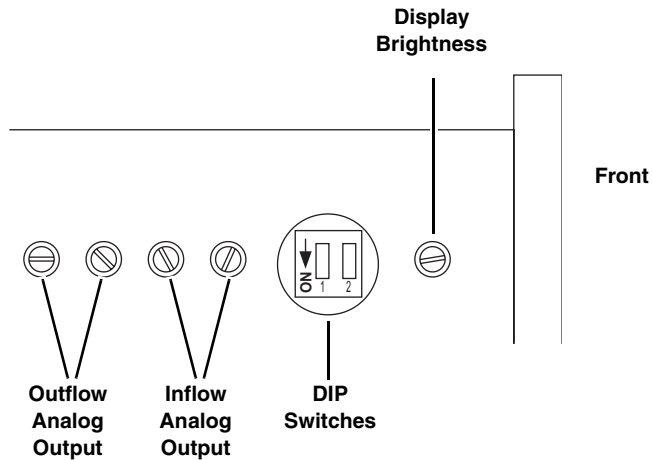

Figure 4-1 Location of Pots and Dip Switches

#### 4.1.1 Display Brightness

The display brightness can be set with a miniature screwdriver. The adjustment potentiometer is located in the hole on the left side of the instrument, closest to the front. Adjust the potentiometer for the desired brightness.

#### 4.1.2 Analog Output Adjustments

The analog outputs are factory-adjusted, but can be recalibrated. The four holes on the left side of the 4501 housing are for adjusting the analog outputs. To calibrate:

1. Remove existing wiring from the terminals of the output channel to be adjusted.
2. Install a 250 ohm resistor between the + and – terminals of the analog output to be adjusted.

 **Note**

Each output (Outflow and Inflow) channel has a pair of potentiometers. Refer to Figure 4-1 for the correct location of the pairs.

```
CHANGE Analog  
output Out: 100%
```

```
CHANGE Analog  
output Out: 000%
```

3. Connect a voltmeter across the + and – terminals.
4. Access the settings mode by pressing SELECT for three seconds. Press ENTER until the 4501 displays the “CHANGE Analog output” screen. Press the UP button until the displayed percentage reads 100%.
5. Adjust the left potentiometer of the pair to read 5 volts when the analog output display reads 100%.
6. Press the DOWN button until the displayed percentage reads 0%.
7. Adjust the right potentiometer of the pair to read 1 volt when the analog output display reads 0%.

These steps can be repeated for the other analog output channel.

### 4.1.3 DIP Switches

The DIP switches on the left side of the unit are only used when changing the internal software of the instrument. Otherwise, the two DIP switches should always be OFF. If you receive new software for the instrument, the steps to follow to program the instrument will be included with the software documentation.

## 4.2 Fuse Replacement

The 4501 has internal fuses to protect its circuits from errant digital input signals. If blown, the 120mA board-mounted fuses can be replaced.

  **WARNING**

**Fuse replacement should only be performed by a trained service technician.**

  **WARNING**

**Live electrical circuits may cause personal injury or death from electrical shock, or may cause fire or equipment damage. Disconnect the instrument from mains power and all input/outputs before servicing the internal fuses.**

*To replace the fuse:*

1. Disconnect power supply.
2. Disconnect the terminal blocks.
3. Remove back cover by carefully prying it off.
4. Remove the second board from top.
5. Replace the blown fuse and reassemble the 4501.

### 4.3 Troubleshooting

The following table list symptoms and possible causes.

 **WARNING**

**Troubleshooting should be performed by a trained technician. The following procedures are performed while power is applied to the 4501. Although lethal voltages do not exist on the input power and analog output terminals, dangerous voltages may be present on the analog or digital channels and nearby terminals on the pump station control panel.**

Symptom	Possible Cause
Nothing appears on the display.	Power supply not connected. Power supply wires not well connected to terminal. Fuse blown or missing. No power at AC voltage receptacle. Turn display brightness adjustment pot clockwise.
The 4501 will not download data.	Communication settings on incorrect mode (direct, modem, or external modem). Instrument was not powered off after change in communication settings. The so-called Null modem cable is not really a null modem cable.
When one pump goes ON, I see an X on another pump.	Use a voltmeter to check voltage between the ground and the OFF pump when another pump in ON; it should be near 0 volts. If it is not, check to see that the ground is indeed solidly grounded. Try the neutral/common and retry. Call the electrician and ask them how to correct the problem. It is a common, but abnormal condition.
I do not have the same voltage on all my inputs.	Use the ground as the common. This way, you can connect 12 VDC with 120 VAC without any problem. (See section 2.3)

### 4.4 Advanced Troubleshooting

We recommend that the unit be returned to an approved service facility for servicing beyond what is covered in this instruction manual. At times, advanced diagnostic and calibration tools are necessary to properly service the instrument.

However, If you need technical assistance with an Isco Product, consult with Isco's Technical Service Department. Often a problem can be solved in the field with just a little extra help.

Contact information can be found at the front of this manual.



# 4501 Pump Station Monitor

---

## *Appendix A Accessories*

### A.1 Accessories List

Accessories can be purchased by contacting Isco's Customer Service Department. Contact information can be found at the front of this manual.

**Pumplink Software for Windows** - Single License. Used to program the 4501 Pump Station Monitor. Software also retrieves data and for storage and analysis. Presents data in graphs or tables. . . . . 60-4504-003

**Power Supply** for 4501 Pump Station Monitor. Universal AC input (100 to 240 VAC, 50 to 60 Hz). Includes external fuse holder with fuse. Supplied with a 120V grounded AC power cord suitable for most North American users. . . . . 68-4500-018

**Power Supply** for 4501 Pump Station Monitor. Universal AC input (100 to 240 VAC, 50 to 60 Hz). Includes external fuse holder with fuse. May be connected to most international AC power systems with a user-supplied power cord that is terminated with a standard IEC 320 power connector. . . . 60-4504-063

**4501 Interrogator Cable with Stereo Connector.** 6 ft., connects computer 9-pin serial connector to stereo connector on front of flow monitor. . . . . 60-4504-058

**4501 Interrogator Cable with 9 pin Connectors.** 6 ft., connects computer 9-pin serial port connector to 9-pin connector on back of flow monitor. . . . . 60-4504-060

**9-pin to 25-pin** serial port adapter kit. . . . . 60-4509-001

**Removable Memory Card, 1 Mbyte capacity.** PCMCIA Type I static RAM memory card. Capable of retrieving and storing data from a minimum of 16 pump stations. . . . . 60-4503-009

**Removable Memory Card, 2 Mbyte capacity.** PCMCIA Type I static RAM memory card. Capable of retrieving and storing data from a minimum of 32 pump stations. . . . . 60-4503-010

**Terminal Connector, 6 position.** Allows field wiring to remain in place when 4501 is removed from pump station. 6 position, for power supply input and two 4 to 20 mA outputs (inflow and outflow). . . . . 60-4504-009

**Terminal Connector, 10 position.** Allows field wiring to remain in place when 4501 is removed from pump station. 10 position, for 8 analog inputs. . . . . 60-4504-010

**Terminal Connectors, 12 position.** Allows field wiring to remain in place when 4501 is removed from pump station. 12 position, for 3 pump inputs, 4 additional digital inputs (rain gauge, etc.), and 2 relay outputs. . . . . 60-4504-011

**Current Clamp, for one pump.** Used to connect a 4501 to a pump motor. Current clamp attaches around a motor lead to sense current flows up to 200 amps. Monitors the current of a single pump. Requires 12 VDC power, which may be available from a 4501 power supply (not included). . . . . 60-5314-025

**Current Clamps, for two pumps.** Includes two current clamps and a 4501 power supply. Factory wired so that installation only requires plugging into AC power and connecting current clamps to the conductors. . . . . 60-5314-097

**Current Clamps, for three pumps.** Includes three current clamps and a 4501 power supply. Factory wired so that installation only requires plugging into AC power and connecting current clamps to the conductors. . . . . 60-5314-174

**4501 Instruction Manual.** . . . . . 60-4503-016

**NEMA 4X Enclosure.** A lockable enclosure with internal wiring and overload protection for the 4501. Available in portable and fixed-installation configurations . . . . . CALL

## ***Isco One Year Limited Factory Service Warranty \****

Isco warrants covered products against failure due to faulty parts or workmanship for a period of one year (365 days) from their shipping date, or from the date of installation by an authorized Isco Service Engineer, as may be appropriate.

During the warranty period, repairs, replacements, and labor shall be provided at no charge. Isco's liability is strictly limited to repair and/or replacement, at Isco's sole discretion.

Failure of expendable items (e.g., charts, ribbon, tubing, glassware, seals and filters), or from normal wear, accident, misuse, corrosion, or lack of proper maintenance, is not covered. Isco assumes no liability for any consequential damages.

Isco specifically disclaims any warranty of merchantability or fitness for a particular purpose.

This warranty applies only to products sold under the Isco trademark and is made in lieu of any other warranty, written or expressed.

No items may be returned for warranty service without a return authorization number issued from Isco.

This warranty does not apply to the following products: Process Analyzers, SFX 3560 SFE Extractor, 6100 VOC Sampler.

The warrantor is Isco, Inc. 4700 Superior, Lincoln, NE 68504, U.S.A.

*\* This warranty applies to USA customers. Customers in other countries should contact their Isco dealer for warranty service.*

*In the event of instrument problems, always contact the Isco Service Department, as problems can often be diagnosed and corrected without requiring an on-site visit. In the U.S.A., contact Isco Service at the numbers listed below. International customers should contact their local Isco agent or Isco International Customer Service.*

### **Return Authorization**

A return authorization number must be issued prior to shipping. Following authorization, Isco will pay for surface transportation (excluding packing/crating) both ways for 30 days from the beginning of the warranty period. After 30 days, expense for warranty shipments will be the responsibility of the customer.

**Shipping Address:** Isco, Inc. - Attention Repair Service  
4700 Superior Street  
Lincoln NE 68504 USA

**Mailing address:** Isco, Inc.  
PO Box 82531  
Lincoln NE 68501 USA

**Phone:** Repair service: (800)775-2965 (lab instruments)  
(800)228-4373 (samplers & flow meters)  
Sales & General Information (800)228-4373 (USA & Canada)

**Fax:** (402) 465-3001

**Email:** service@isco.com

***Isco, Inc.***

[www.isco.com](http://www.isco.com)

